

Arbuscular Mycorrhizas:

Producing and Applying Arbuscular Mycorrhizal Inoculum

M. Habte and N. W. Osorio

Department of Tropical Plant and Soil Sciences



CTAHR

College of Tropical Agriculture & Human Resources
University of Hawaii at Manoa

Acknowledgments

We are grateful to Dr. Mark Brundrett, who generously gave us permission to use his drawings, including the one on the cover, in this publication.

This work was funded by the Hawaii Renewable Resources Extension Program, supported by RREA Smith-Lever 3D funds from CSREES/USDA.

About this publication

The information contained herein is subject to change or correction. Procedures described should be considered as suggestions only. To the knowledge of the author, the information given is accurate as of July 2001. Neither the University of Hawaii at Manoa, the UH College of Tropical Agriculture and Human Resources,

the United States Department of Agriculture, nor the author shall be liable for any damage or injury resulting from the use of or reliance on the information contained in this publication or from any omissions to this publication. Mention of a company, trade, or product name or display of a proprietary product does not imply approval or recommendation of the company or product to the exclusion of others that may also be suitable.

This information may be updated in more recent publications posted on the CTAHR Web site, <www2.ctahr.hawaii.edu>. For information on obtaining additional copies of this book, contact the Publications and Information Office, CTAHR-UHM, 3050 Maile Way (Gilmore Hall 119), Honolulu, HI 96822; 808-956-7036; 808-956-5966 (fax); e-mail <ctahrpub@hawaii.edu>.

Table of contents

Arbuscular mycorrhizal associations	3
AMF functions	4
Sources of AMF inoculum	5
Producing crude inoculum	9
Producing root inoculum	12
Producing hydroponic and aeroponic inoculum	13
Inoculum storage	13
Amount of inoculum to apply	15
Evaluating effectiveness of AMF inoculum	16
Appendixes	
1. Extracting AMF spores from soil or crude inoculum	22
2. Extracting spores from a crude inoculum and determining their viability	25
3. A modified Hoagland's solution II for use in AMF inoculum production	27
4. Hydroponic production of AMF inoculum	28
5. Aeroponic production of AMF inoculum	30
6. Detecting and quantifying AMF colonization of roots	31
7. Determining the abundance of infective propagules in crude inoculum and in soil	33
8. Determining AMF symbiotic effectiveness by the pinnule technique and similar nondestructive approaches	35
9. Determining the P-sorption capacity of soils	39
10. Monitoring the symbiotic effectiveness of indigenous AMF	41
11. Table of most probable numbers for use with 10-fold dilutions, five tubes per dilution	42

Copyright 2001 © College of Tropical Agriculture and Human Resources, University of Hawaii at Manoa; ISBN 1-929325-10-X

Published by the College of Tropical Agriculture and Human Resources (CTAHR) and issued in furtherance of Cooperative Extension work, Acts of May 8 and June 30, 1914, in cooperation with the U.S. Department of Agriculture. Andrew G. Hashimoto, Director/Dean, Cooperative Extension Service/CTAHR, University of Hawaii at Manoa, Honolulu, Hawaii 96822. An Equal Opportunity / Affirmative Action Institution providing programs and services to the people of Hawaii without regard to race, sex, age, religion, color, national origin, ancestry, disability, marital status, arrest and court record, sexual orientation, or veteran status. CTAHR publications can be found on the Web site <<http://www2.ctahr.hawaii.edu>> or ordered by calling 808-956-7046 or sending e-mail to ctahrpub@hawaii.edu.

Arbuscular Mycorrhizas: Producing and Applying Arbuscular Mycorrhizal Inoculum

To one degree or another, most plants in their natural habitats function under the influence of a special group of soil fungi known as arbuscular mycorrhizal fungi (“AM fungi” or AMF). The existence of these fungi has been recognized for more than a century, although they did not receive the attention they deserve until approximately 40 years ago. Worldwide, interest in AM fungi has now reached a point wherein any discussion of agricultural biotechnology that does not include their role in plant productivity can hardly be considered complete.

Interest in AM fungi has been gradually growing in Hawaii over the past 18 years. Many individuals and organizations concerned with managing native plant species, restoring natural ecosystems, and producing agronomic, horticultural, and forest plants with minimal chemical inputs are interested in applying AMF technology. But a major, recurring challenge to large-scale utilization of AMF is the lack of availability of large quantities of high-quality AMF inoculum. The problem is largely due to the fact that AM fungi are obligate symbionts—they require the presence of actively growing plants during their reproduction. They therefore cannot be cultured on laboratory media in the same manner as other beneficial soil microorganisms such as *Rhizobium* bacteria. Fortunately, specialized techniques for AMF inoculum production have been in development at the University of Hawaii and elsewhere.

During the past few years, we have received numerous inquiries from people in Hawaii and beyond about AMF and their inocula. This publication will try to answer common questions about AM fungi and pro-

vide information that will enable interested individuals to produce and then evaluate AMF inocula with minimal external assistance.

Arbuscular mycorrhizal associations

The term “mycorrhiza” was coined by A. B. Frank, a researcher in Germany, more than 100 years ago. It means “fungus-root,” and stands for the mutualistic association existing between a group of soil fungi and higher plants. There are many types of mycorrhizal associations,⁽⁴⁷⁾ of which the endomycorrhizal association of the vesicular arbuscular (VA) type are the most widespread geographically as well as within the plant kingdom. VA mycorrhizal fungi invade cortical cells inter- and intra-cellularly and form clusters of finely divided hyphae known as arbuscules in the cortex. They also form membrane-bound organelles of varying shapes known as vesicles inside and outside the cortical cells. Arbuscules are believed to be sites of exchange of materials between the host and the plant. Vesicles generally serve as storage structures, and when they are old, they could serve as reproductive structures. Vesicles and arbuscules together with large spores constitute the diagnostic feature of the VA mycorrhizal associations (Figure 1). Because vesicles are absent in two of the seven genera containing these fungi, the term that is currently preferred by many researchers to represent the association is arbuscular mycorrhizal (AM) fungi rather than vesicular-arbuscular (VA) mycorrhizal fungi. Arbuscular mycorrhizal fungi occur on a wide spectrum of temperate and tropical plant species and are absent in less than 30 plant families^(68, 99).

Figure 1. Diagram of a longitudinal section of a root showing the characteristic structures of arbuscular mycorrhizal fungi.

(Adapted from M. Brundrett.⁽⁵⁷⁾)

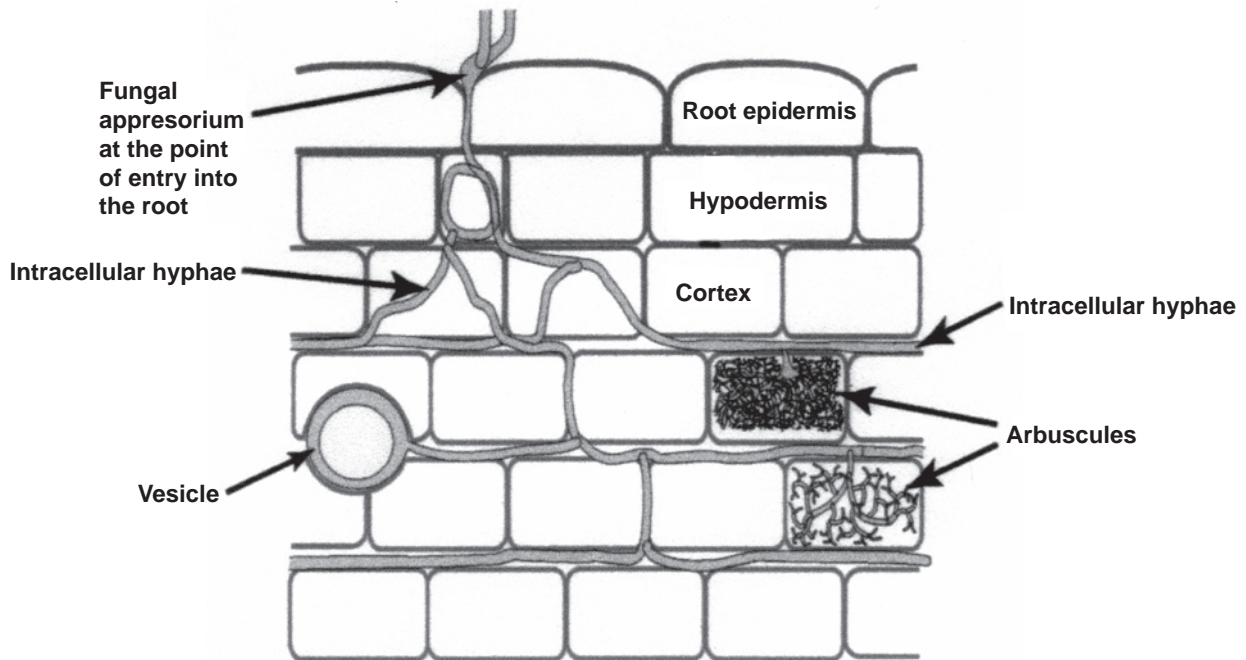

AMF functions

Roles in plant nutrition

AM fungi absorb N, P, K, Ca, S, Fe, Mn, Cu, and Zn from the soil and then translocate these nutrients to the plants with whose roots they are associated.^(33, 49, 80, 101) Their most consistent and important nutritional effect is to improve uptake of immobile nutrients such as P, Cu, and Zn.^(73, 84) AM fungi have their greatest effect when a host plant not associated with them is deficient in P. They are also very useful to plant species that inherently lack either morphological or physiological mechanisms for efficient P uptake.^(68, 74) Consequently, enhancement of growth of plants associated with AMF is explained in most instances by improved P nutrition.⁽¹⁰⁾

Another advantage to associated plants is improved maintenance of a balanced supply of nutrients. This occurs because plants grown in association with AMF can grow with only a fraction of the P required for growth by plants lacking a mycorrhizal association. Moreover, when P is applied at high concentrations, as is commonly done when growing plants in soil where AMF are absent, it can cause nutritional disorders be-

cause of its antagonistic interactions with other nutrients, or because it inhibits mycorrhizal formation⁽⁷¹⁾. Studies with the forage tree *Leucaena leucocephala*, which is highly dependent on mycorrhizal association, have shown that the AMF symbiosis can decrease the plant's external P requirement, reducing it to as much as 40 times less than the plant would require for good growth in the absence of AMF (MH, unpublished).

The ability of AMF to reduce plants' external P requirement has an important environmental benefit. High levels of P in soils can result in pollution of bodies of water when eroded soil rich in P is deposited in them. P enrichment of water bodies causes eutrophication^(20, 92) due to excessive development of algae, cyanobacteria, and aquatic plants, and this condition impairs the usefulness of these waters. When plants rely on AMF association rather than heavy P fertilization, risks to water quality are reduced. Arbuscular mycorrhizal fungi, therefore, are an important component of nutrient management programs that aim to reduce environmental pollution.

Roles not directly related to nutrition

A growing body of research suggests that AMF could contribute to plant health and productivity independently of their role in enhancing nutrient uptake. For example, the fungi have been found to be involved in the suppression of plant diseases,^(53, 80, 102) including nematode infection.^(18, 45) AMF stimulate hormone production in plants,⁽²⁹⁾ aid in improving soil structure,^(9, 104, 105) enhance leaf chlorophyll levels,⁽¹⁰³⁾ and improve plant tolerance to water stress, salinity, soil acidity, and heavy metal toxicity.⁽⁸⁾ Some of these functions may be the indirect effects of improved P nutrition.^(82, 93)

Mechanisms of enhanced P uptake

In soils not adequately supplied with P, plant demand for this nutrient exceeds the rate at which it diffuses into the root zone, resulting in zones of P depletion surrounding roots. It is believed that AMF help overcome this problem by extending their external hyphae from root surfaces to areas of soil beyond the P depletion zone, thereby exploring a greater volume of the soil than is accessible to the unaided root.^(50, 58) The external hyphae of some AMF may spread 10–12 cm from the root surface. Assuming a radial distribution of hyphae around roots, it has been estimated that the volume of soil explored by the mycorrhizal root exceeds that explored by the unaided root by as much as 100 times.⁽⁹³⁾

AM fungal hyphae are 2.5–5 times smaller in diameter than plant roots and therefore have a greater surface area per unit volume. This surface area makes the fungi much more efficient than roots in the uptake of P⁽¹⁰⁾. Moreover, the smaller diameter of AMF hyphae allows them to explore micropores in the soil that are not accessible to roots. And, studies carried out in solution culture have shown that AMF hyphae have a higher affinity for P than do roots.⁽⁵⁴⁾

AM fungi may have biochemical and physiological capabilities for increasing the supply of available P or other immobile nutrients. These mechanisms may involve acidification of the rhizosphere,⁽⁶⁾ increases in root phosphatase activity,⁽³⁰⁾ and excretion of chelating agents.

Sources of AMF inoculum

Soil as inoculum

Soil from the root zone of a plant hosting AMF can be used as inoculum. Such soil inoculum is composed of soil, dried root fragments, and AMF spores, sporocarps, and fragments of hyphae. Soil may not be a reliable inoculum unless one has some idea of the abundance, diversity, and activity of the indigenous AMF. Figures 2–5 illustrate the effectiveness as an AMF inoculum, relative to that of a crude inoculum, of surface soils collected from the islands of Kauai, Hawaii, and Oahu. Note that the effectiveness of the indigenous AMF in the Hanelei and Wahiawa soils is significantly inferior to that of the crude inoculum, while the effectiveness of the Piihonua and Kapaa soils was barely detectable even after 70 days of contact with the host plant. These findings suggest that soil can sometimes be very inefficient as a source of AMF inoculum.

An additional concern with the use of soil as inoculum is the possible transfer of weed seeds and pathogens with the soil. Figuring out how much soil to add as inoculum to a growth medium or a field is another challenge, because the abundance and viability of AMF propagules in the soil is often uncertain. Soils are thus AMF inoculum sources of last resort, and their use should be avoided if other types of inoculum are available.

Spores can be extracted from soil and used as inoculum (Appendix 1), but such spores tend to have very low viability or be dead. If the spores were collected from the root zone of an actively growing plant, and if the plant can be determined to be infected with AMF, then the spores might be reasonably viable. If they are not, soil or root tissue from the site can be taken to start a “trap culture” to boost the number of viable spore propagules for isolation and further multiplication. These roots and soil are either mixed into the growth medium or applied in a band below the soil surface, as illustrated in Figure 6. Germinated seeds of the indicator plant are then planted and grown long enough for formation of a mixed culture containing mature AMF spores, which are then extracted, separated into morphological types, identified, and used as starter cultures. Identification can be done concurrently with the production of inoculum.

Figure 2. Indigenous AMF in the Hanalei soil (Typic Fluvaquent, 0–15 cm, Kauai, Hawaii) were less effective than *Glomus aggregatum*.

(Effectiveness was determined as in Appendix 9; MH, unpublished data).

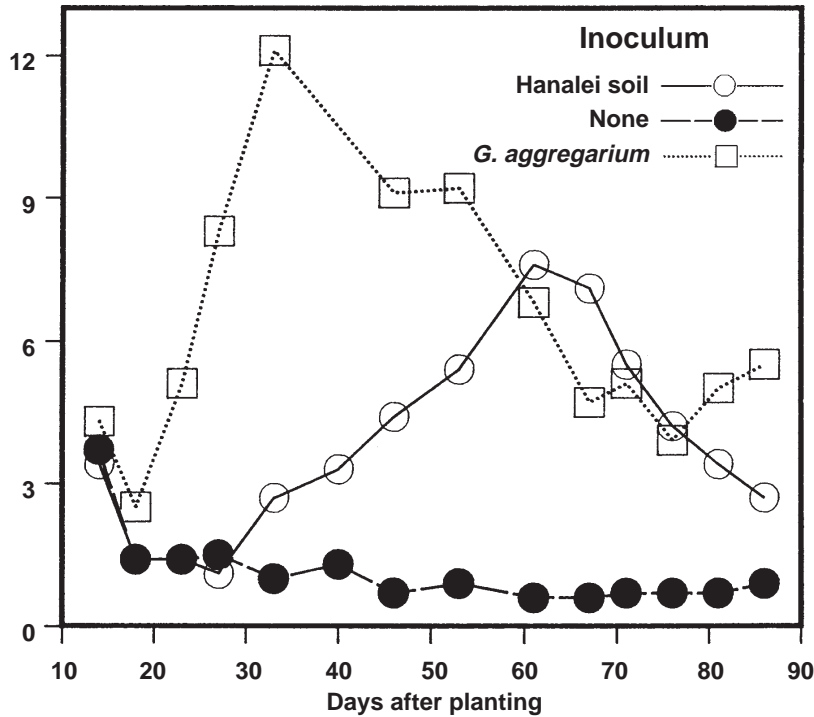

Inoculating with *Glomus aggregatum* was highly effective in boosting plant P uptake compared to no inoculum. The Hanalei soil shows evidence of indigenous AMF activity, but the effect was delayed compared to that of the AMF inoculum, and it took 2 months for pinnule P levels to reach comparable levels.

The Wahiawa soil (Fig. 5) was similar to the Hanalei soil. In contrast, the Kapaa soil (Fig. 4), like the Piihuna soil below (Fig. 3), had no effect as a source of AM fungi.

Figure 3. The number of indigenous AMF in the Piihuna soil (Typic Hydrudand, 0–15 cm, island of Hawaii) was so low that their activity was not detected after 70 days.

Effectiveness was determined as in Appendix 11. Indigenous AMF were from two soils, one from a site at which *Acacia koa* establishment was not a problem, the other from a site where its establishment was difficult. Data points further apart than the length of the vertical bar were significantly different (MH, H. Ikawa, and P. Scowcroft, unpublished data).

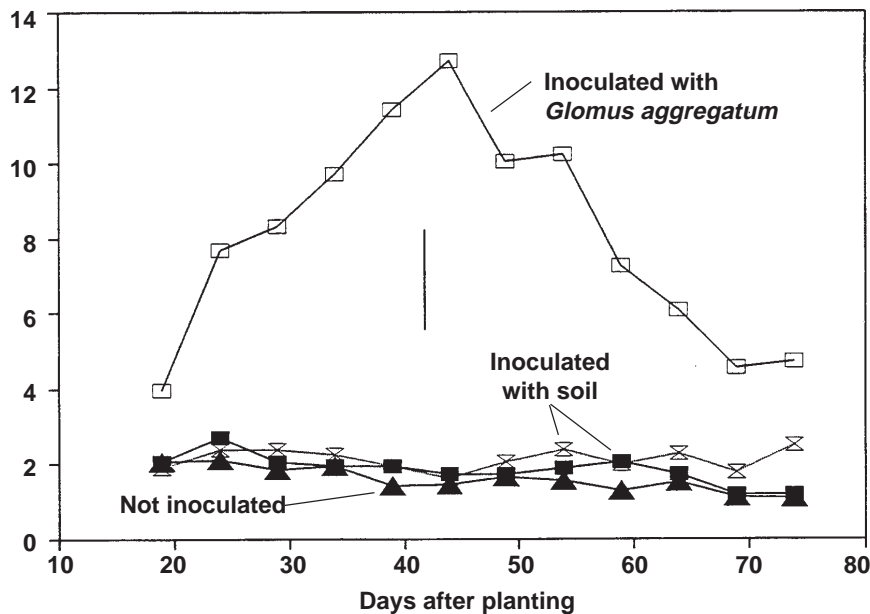

Soil inoculum was not significantly better than no inoculum

Figure 4. Like the soil shown in Figure 3, the number of indigenous AMF in the Kapaa soil (Typic Gibbsiorthox, 0–15 cm, Kauai, Hawaii) was so low that they were not effective in increasing plant P uptake until 80 days after planting.

(Effectiveness was determined as in Appendix 10; MH, unpublished data).

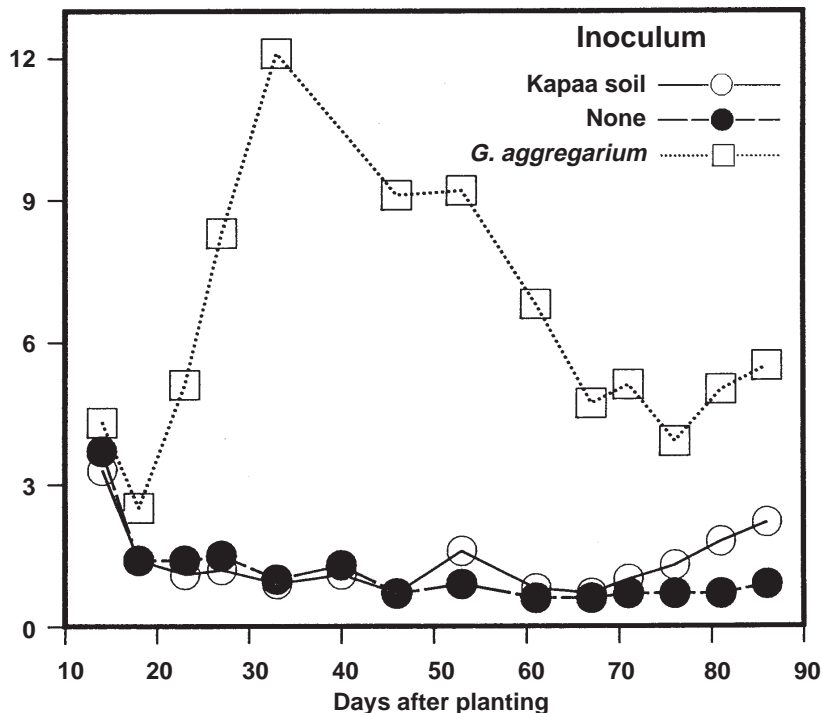

Figure 5. The indigenous AMF in the Wahiawa soil (Rhodic Eutruxox, 0–15 cm, Oahu, Hawaii) affected plant P uptake in a manner similar to that of the Hanalei soil in Figure 2.

(Effectiveness was determined as in Appendix 10; MH, unpublished data).

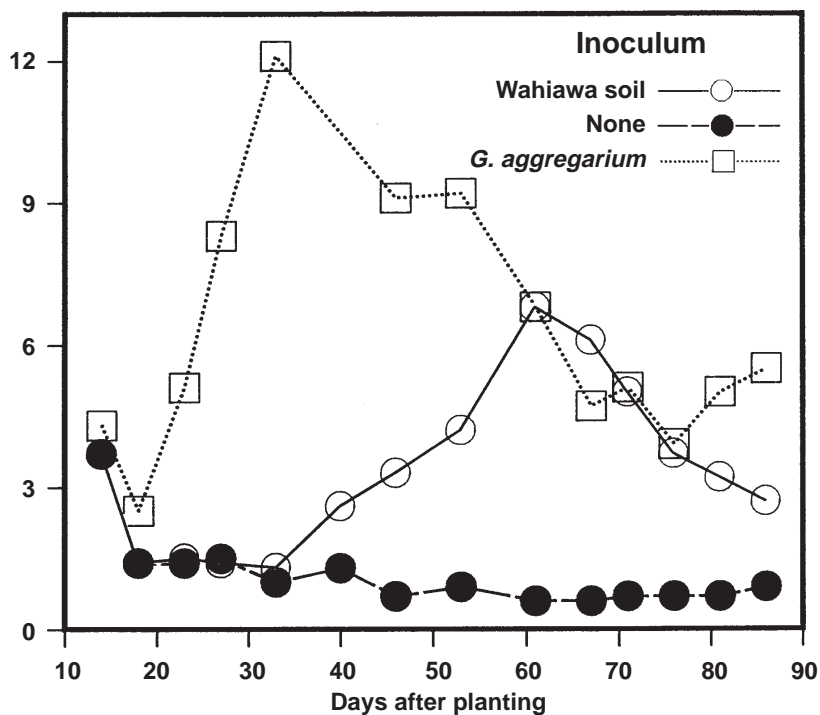
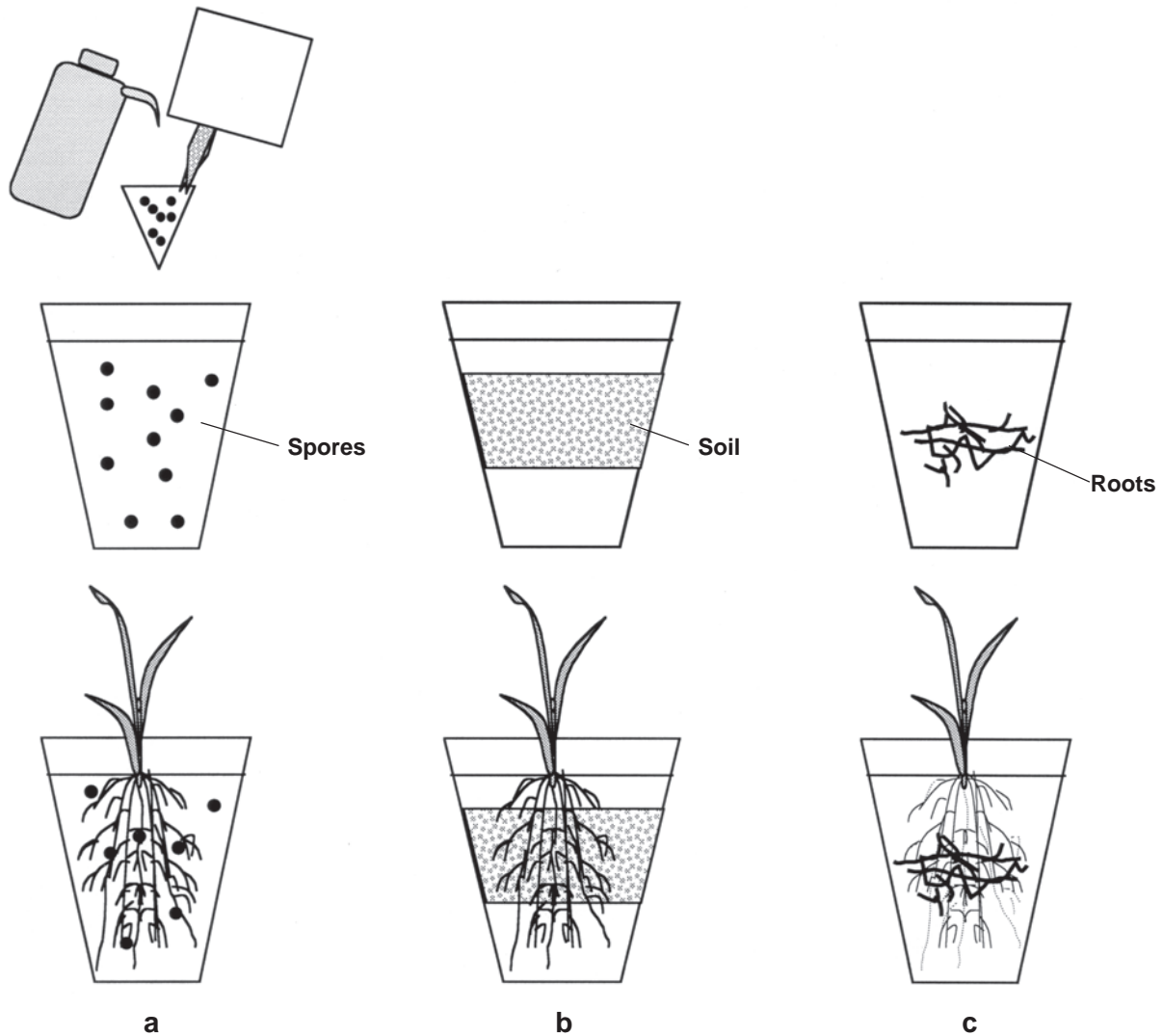

Figure 6. Starting AMF inoculum from spores (a) and trap cultures from soil (b) and roots (c).
 (Adapted from M. Brundrett⁽¹⁴⁾).



Crude inoculum

Crude inoculum is obtained after a known isolate of AMF and a suitable host are grown together in a medium optimized for AMF development and spore formation. Such inoculum is the most common type available for large-scale crop inoculation. It consists of spores, fragments of infected roots, pieces of AMF hyphae, and the medium in which the inoculum was produced.

Spores can be extracted from such an inoculum by wet-sieving and decanting, as illustrated in Appendix 2, and used, alone, before or after surface disinfection.

But because of the time required and the tediousness of spore extraction, the use of spores alone is generally limited to experiments and the initiation of pot cultures of AM fungi. Also, spore inocula are known to initiate AMF colonization less rapidly than crude inocula, possibly because crude inocula contain a greater number of different types of infective propagules.

Root inoculum

Infected roots of a known AMF host separated from a medium in which crude inoculum was produced can also serve as a source of inoculum.

Producing crude inoculum

The degree to which one succeeds in producing high-quality inoculum will depend on a number of factors, most important of which are the

- state of the starter culture
- type of nurse plant
- support medium, and
- growth environment.

The aim is to bring the plant and the AMF together in a physical and chemical environment that is most conducive for the activity of the fungi and the formation of abundant hyphae and spores.

The physical environment

The solid media most commonly used for the production of crude inoculum are soil and sand, or a mixture of these. “Sand” here refers to silica sand, not coral sand. Sand derived from coral is calcium carbonate and is not suitable for inoculum production. In our research program, the preferred medium is a manufactured sand made of crushed basalt, which we refer to as “mansand” and is also called masonry sand (it is available from Ameron Hawaii). We use mansand alone or a 1:1 mixture (by weight) of mansand and soil. Silica sand, mansand, and sand-soil mixtures have the distinct advantage of drying more rapidly than soil alone once the inoculum production cycle is completed. This is important to minimize the growth of other microorganisms in the inoculum during the drying process. Mansand is screened into various particle size categories; we use particles < 2 mm. Soil alone can be used for producing crude inoculum, although with certain soils poor drainage may be a problem. Removing roots from soil at the end of inoculum production is more difficult than from sand or sand-soil mixture.

Unless the host-fungus combination of interest is tolerant of soil acidity, AMF colonization will be hampered by Al or Mn toxicity if soils of pH 5 or lower are used without liming.⁽⁹⁴⁾ Mixing the soil with mansand, which has a high pH, tends to reduce the potential for toxicity.

The initiation and development of AMF activity depends on the host’s supply of photosynthate and on its root exudations. If these are reduced by conditions such as shading or defoliation, AMF colonization can be reduced. The host must have sufficient photosyn-

thate to support the formation and development of AMF on its roots without adverse effects on itself^(25, 37). Consequently, environmental variables such as light intensity, soil and air temperature, and soil water status should be favorable for normal plant function.

AM fungi development is favored when the moisture content of the medium is slightly less than optimal for plant growth. A moisture content of approximately 0.1–0.2 bars appears to be adequate for inoculum production. Temperature is another important environmental factor that regulates AMF activity. Soil temperature is generally considered to be more important than air temperature, and temperatures that are slightly higher than the optimum for host plant development appear to favor AMF development. We have been able to produce high-quality inocula in the greenhouse under natural light during the period March–July (21°19’N, 157°58’W) at a soil moisture content of near-maximum water holding capacity.

Container types

Various containers can be used to hold solid matrixes during inoculum production, including plastic bags and pots made of concrete, clay, and plastic. They should have holes in the bottom to ensure adequate drainage. To minimize the amount of light reaching the medium, the containers should not be translucent. If clear material must be used, it should be painted or enclosed by wrapping in an opaque material. We have used 2–10 kg of medium per container with satisfactory results.

Starter culture

The inoculum from which a crude inoculum is started can be a pure isolate obtained from another researcher, a culture collecting and curating organization such as INVAM, or a reliable commercial culture producing firm. Or, an isolate can be made from a specific soil by the person producing the inoculum. The procedure for obtaining an isolate from soil is described in Appendix 1.

The amount of starter inoculum to use will depend on its quality. The culture must be highly infective, contain at least four infective propagules per gram, and be free of pathogenic microorganisms. The aim is to inoculate the inoculum-production medium at a rate of 500 infective AMF propagules per kilogram of medium. Other qualities of a starter inoculum are discussed in the section on production of root inoculum.

Nurse plant species

The nurse plant grown to host AM fungi in the inoculum production medium should be carefully selected. It should grow fast, be adapted to the prevailing growing conditions, be readily colonized by AMF, and produce a large quantity of roots within a relatively short time (45–60 days). It should be resistant to any pests and diseases common in the inoculum-production environment. Additional criteria for selecting nurse plant species are considered in connection with root inoculum production.

Nutrient management

Managing the chemical composition of the medium in which the AM fungi interact with their host can be more problematic than managing the physical environment for inoculum production. Because AMF directly influence the uptake of only those nutrients whose movement toward the root surface is limited by diffusion, nutrients not limited by diffusion must be supplied in the medium in sufficient amounts for normal host growth. Moreover, the supply of immobile nutrients, particularly phosphorus (P), and the supply of nitrogen (N) must be carefully monitored, because these nutrients appear to regulate the formation of the arbuscular mycorrhizal association. Also, P in high concentrations is known to suppress AMF colonization of roots^(41, 61, 76) (Figure 7). Because of this suppression and because different species of plants can have different P uptake efficiencies, it is important to make sure that the concentration of P in the growth medium is appropriate for the particular nurse plant. Species that are very highly to highly dependent on AMF for nutrient uptake and growth are generally known to have higher external P requirements than those with a lower degree of mycorrhizal dependency. The highly dependent species can grow in soils with solution P concentrations of 0.02–0.2 mg/L or higher and still sustain high levels of mycorrhizal colonization on their roots (Figure 8). However, such P concentrations will significantly limit AMF colonization in species that are only moderately to marginally dependent on AMF, and these species must therefore be grown at a soil P concentration lower than 0.02 mg/L.

If inoculum is produced using media with extremely low P buffer capacity, such as silica sand or crushed basalt, the best approach is to feed the nurse plant through periodic additions of a nutrient solution such as Hoagland's solution⁽⁵²⁾ with the P concentra-

tion adjusted to 8 mg/L (MH, unpublished data). This solution can be added to support matrixes at the rate of 200 mL/kg of medium once a week. Phosphorus-free Hoagland's solution (Appendix 3) could also be used in combination with rock phosphate, which can be mixed with the matrix at the rate of 5 mg P/kg (MH, unpublished data).

Compared to P, the effect of inorganic N on AMF colonization is less understood. At high concentrations, N is believed to inhibit root colonization, and the ammonium form is reported to be particularly toxic.⁽¹¹³⁾ This form of N is particularly problematic if its concentration exceeds 200 mg/kg.^(16, 4) Our research has shown that N concentration of 80–120 mg/L are adequate for inoculum production purposes (MH, unpublished data). If the nurse plant is a legume and the seed or growth medium is inoculated with appropriate rhizobia, most or all of the N demand of the plant can be met by biological N₂ fixation. However, in many instances a starter N level not exceeding 25–50 mg/kg will be required during the initial phase of the establishment of the legume-rhizobium symbiosis.

All other essential nutrients, of course, must be supplied in quantities sufficient for normal plant growth. The levels of these nutrients we generally use in our studies involving a 1:1 mansand-soil mixture (pH 6.2) are (in mg/kg of medium⁽⁴⁾) K 250, Mg 212 (as MgSO₄), Zn 10, Cu 5, B 0.1, Mo 0.5. Contamination of the pot culture by undesired organisms can be minimized by covering the surface of the medium with sterilized sand or gravel.

Duration of growth

To ensure that most of the spores in the inoculum are mature, it is essential to grow the nurse plant in the inoculum-production medium for 12–14 weeks. The medium is then allowed to dry slowly by reducing the frequency of watering over a week and then withdrawing water completely for another week. If at the end of the last week the plant is dry, it is removed from the growth medium. The roots of the plant can be chopped into fragments 1 cm long and mixed with the medium, or they can be used separately as root inoculum. The moisture content of the medium at this time should be 5% or lower. If not, the crude inoculum must be spread on a clean surface in an environment with low humidity (RH ≤ 65%) and allowed to air-dry until the desired moisture content is reached.

Figure 7. The greater the concentration of solution P in the growth medium, the less root colonization by AM fungi will occur. (Peters and Habte 2001.)

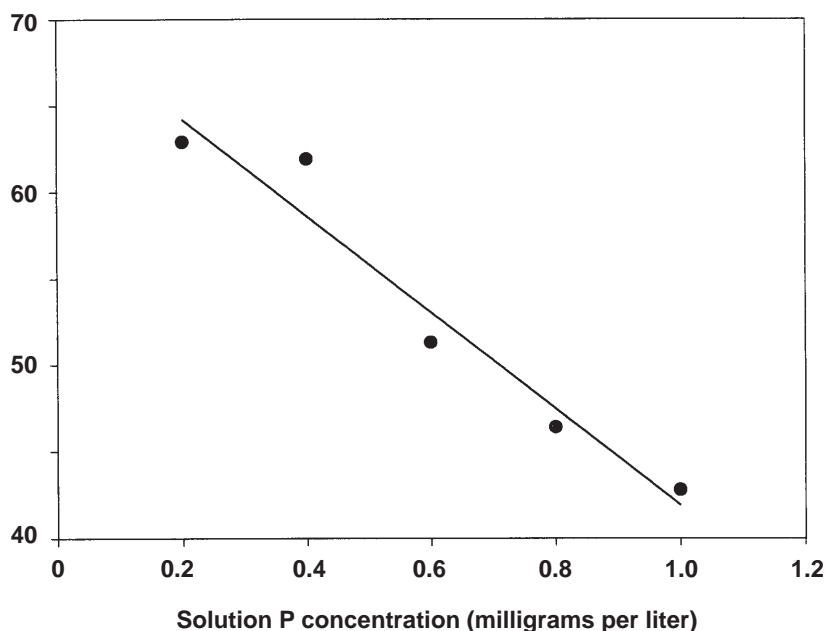
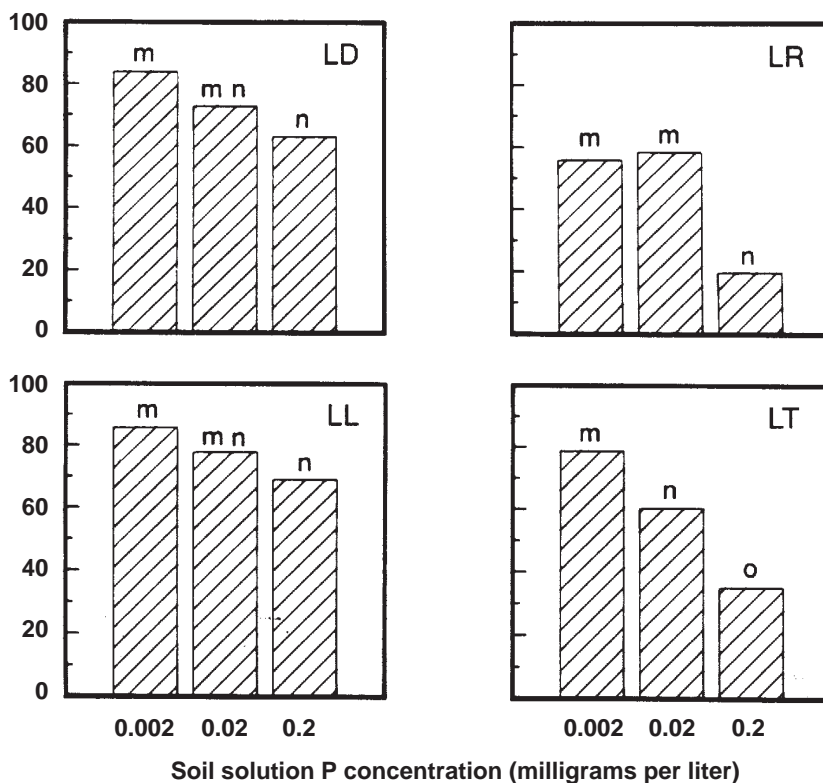

Figure 8. Sensitivity of AMF colonization to soil solution P concentration in four *Leucaena* species. Means followed by the same letter within a *Leucaena* species are not significantly different from each other at the 5% level.⁽⁷⁴⁾



The two species on the left (*L. diversifolia* and *L. leucocephala*) had high levels of AMF colonization even at the highest level of soil-solution P. In contrast, root colonization of *L. retusa* and *L. trichodes* was suppressed by high levels of P.

Producing root inoculum

Advantages of using root inoculum

Root inoculum has certain advantages over spore and crude inocula. Root inocula are generally superior to spores in the speed with which they colonize plant roots. They are also much lighter than crude inocula and, most importantly, they require much less time to produce than crude inocula. The basic principles mentioned previously for the production of crude inoculum apply to root inoculum also, except for the fact that the focus here is on the production of large quantities of roots heavily colonized by AMF, rather than on the production of mature spores. This is why root inoculum can be produced in about half the time required to produce crude inoculum.

Aspects of root inoculum production

Production of root mass can be influenced by factors including the type of nurse plant and solid matrix, the number of plants per unit volume of growth medium, and the quality of the starter culture. Sand or crushed basalt are suitable media for root inoculum production from the standpoint of ease of root removal and rapidity of drying at the end of the production period, but they generally yield less root mass under the nutrient regimes commonly used for inoculum production compared to media consisting of pure soil or soil-sand mixtures. Root inoculum can also be produced in non-solid media, and this will be considered in a separate section.

Nurse plant species

Plant species vary in the amount of root mass they produce in a given amount of time and in the extent to which their roots can be colonized by AM fungi⁽⁶⁰⁾. As with nurse plants for crude inoculum production, nurse plants for root inoculum must be carefully selected on the basis of criteria such as adaptability to the prevailing conditions, rapid infectability by numerous AMF, ability to produce abundant root mass within a short time, and inherent resistance to diseases and insects, particularly those that attack plant species for which the inoculum is targeted. To find nurse plants meeting these criteria, we used a soil-sand matrix and tested *Leucaena leucocephala* cv. K8, *Cynodon dactylon*, *Panicum maximum*, *Chloris gayana*, *Sesbania grandiflora*, *S. pachycarpa*, *S. sesban*, *Sorghum sudanese*, and *Zea mays*. The best nurse plants were *C. dactylon*, *S.*

grandiflora, and *Z. mays*, followed by *Panicum maximum* (MH, unpublished data). The more species of appropriate nurse plants one has to choose from the better, because the nurse plant used should be as dissimilar as possible from the plant species for which the inoculum is produced so that the possibility of spread of diseases and parasites through the inoculum to the target plant is minimized.

Common hygienic procedures

Another precautionary measure against disease spread via inoculum is to surface-disinfect nurse plant seeds before germination and then transplant only clean, healthy seedlings into the inoculum-production medium. Standard hygienic practices for greenhouses or growth chambers designated for inoculum production include using clean and disinfected greenhouse ware, maintaining clean bench spaces, and avoiding sloppiness in transferring materials and maintaining the plants.

Nurse plant density

The number of nurse plants per unit weight of medium may influence the quality and quantity of root inoculum produced through its effect on root mass and AMF colonization level. We observed that the number of nurse plants per unit weight of a sand-soil medium had very little impact on the level of AMF colonization, but it had significant impact on root mass of *Zea mays* grown in the medium (MH, unpublished data). Maximum amount of AMF-colonized root mass was obtained at a density of one corn plant per 2 kg of medium.

Starter culture

The quality of AMF culture with which one starts inoculum production will make a big difference in the quality of the final product and the length of time required to produce the inoculum. If a starter inoculum containing few infective propagules is used, the time allowed for the production of inoculum must be extended, or the roots will not be colonized with AMF to the degree desired. Best results both in terms of root mass and AMF colonization levels were observed if the starter inoculum contained 520 infective propagules per kilogram of medium (MH, unpublished data). Increases in the density of infective propagules in excess of this value did not improve AMF colonization levels. The starter culture also must be free from pathogenic and parasitic organisms.

Producing hydroponic and aeroponic inoculum

Although the most common means of producing inoculum employ matrixes like sand, soil, or a mixture of the two, inoculum can be produced in non-solid matrixes. Techniques for doing so include the flowing solution culture technique, the flowing nutrient film technique, the stationary solution technique, and the aeroponic technique.

In the flowing solution culture technique, plants are supported in a structure that allows their roots to be bathed by a continuously flowing solution of dilute nutrients. Plants are colonized by AMF either prior to their introduction into the apparatus,⁽⁵⁵⁾ or they become mycorrhizal after they are introduced into the apparatus.⁽⁵⁴⁾ In the flowing nutrient film technique, roots of plants are bathed with a thin film of flowing nutrient solution.⁽⁷⁸⁾ The stationary solution culture technique is similar to the flowing solution culture technique except that there is no flow and the solution is continuously aerated.⁽¹⁹⁾ These techniques are hydroponic techniques for producing inocula. They are useful for producing limited quantities of clean root inoculum, but their usefulness in spore production is equivocal.

In the aeroponic technique of inoculum production, plant roots are continuously exposed to a nutrient solution mist in a closed chamber. This technique has proven useful in producing clean root inocula and spores.⁽⁶¹⁾

Hydroponic and aeroponic systems require constant monitoring and adjustment of the nutrient solutions involved. More detailed information on the stationary hydroponic, nutrient-film, and aeroponic techniques are given in Appendixes 4 and 5.

Inoculum storage

Both root and crude inocula must be dried to a moisture content of less than 5% before they are stored. We recommend that inoculum be stored in closed plastic containers in a dehumidified room at 22°C. The inoculum should be dried as rapidly as possible to minimize growth of other microorganisms. Crude inoculum can be dried at room or greenhouse temperature by spreading it thinly on a clean surface in a clean, nonhumid environment (RH 65% or lower). We have been able to

store high-quality crude inoculum at 22°C for up to two years with minimal loss in viability. Air-dried cultures of this kind can be packaged in plastic bags and stored at 5°C for at least four years.⁽²⁶⁾ Root inoculum is best dried in a forced-air oven at 60°C.⁽³⁹⁾ Root inoculum dried under greenhouse conditions has a very short shelf life compared to oven-dried material, and even when dried in the oven has a shelf life of less than 100 days at 22°C (Figure 9). We found that after only 14 days of storage the effectiveness of root inoculum was similar to the reference crude inoculum (Figure 9). As the duration of storage increased, the effectiveness of the root inoculum progressively decreased, the decrease being more pronounced if roots were dried in the greenhouse or in an oven at 40°C than if they were dried in the oven at 60°C (Figure 9). It is possible to extend the shelf life of root inoculum through cold storage.⁽⁹⁸⁾ However, this can add substantially to the cost of inoculation.

Inoculum application

Methods of applying AMF inoculum include mixing inoculum with soil, placing inoculum as a layer at various soil depths, applying it as a core below the seed, banding it in much the same way as fertilizers are applied in bands, dipping roots of seedlings in a viscous suspension containing AMF propagules, and placing AMF propagules adjacent to roots at the time of transplanting.

Mixing inoculum thoroughly with the soil is the most straightforward method of applying inoculum in the field as well as in the greenhouse, but it is effective only when large amounts of inoculum are applied. This approach is better with crude inoculum than it is with root inoculum, because root fragments do not readily disperse in soil. Inoculum can be placed at various depths (up to 5 cm) from the surface of the soil as a layer or applied in bands near the seed row (generally 5 cm below and 5 cm to the side of it).

Any type of inoculum can be placed close to seedling roots at the time of transplanting. For example, spores can be pipetted directly onto roots either at the time of transplanting or to roots of an established plant after making a hole adjacent to the roots. Crude inoculum and root inoculum can also be applied to established plants by placing inoculum in holes bored into

Figure 9. The influence of different pre-storage drying conditions on the effectiveness of root inoculum determined in terms of shoot dry weight, root dry weight, and shoot P content 14, 76, and 144 days after storage of root inoculum at 22°C.

Source: Habte and Byappanhalli 1998; MH, unpublished data.

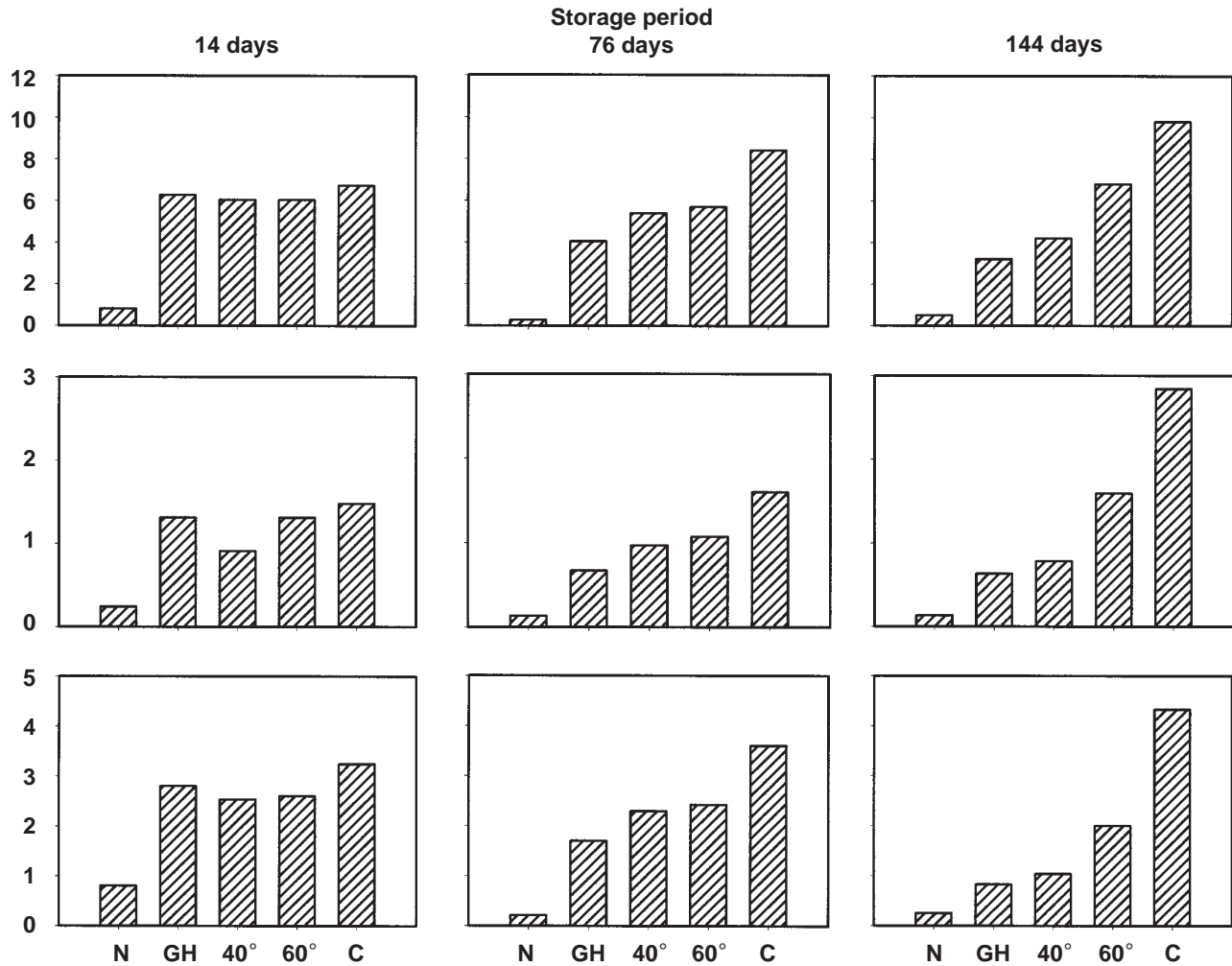

N = not inoculated.⁽³⁹⁾

GH = inoculated with root inoculum air-dried in the greenhouse

40°C, 60°C = inoculated with root inoculum dried in an oven at the temperature indicated

C = inoculated with crude inoculum of *Glomus aggregatum*

Compared to the effectiveness of crude inoculum, root inoculum effectiveness declined with increased duration of storage. The loss of effectiveness when the root inoculum was dried in the greenhouse was greater than when it was oven-dried. Drying the inoculum at 60°C appeared to be better than drying at 40°C.

the soil where roots are likely to be contacted. Before planting, seedling roots can be inoculated by dipping them in a viscous medium (1% methyl cellulose or 10–20% gum arabic) containing AMF propagules, usually spores.

Seed application of AMF inoculum is rare, but has been tried with citrus in Florida with variable results and with *Leucaena leucocephala* at the University of Hawaii (MH, unpublished data).

In a greenhouse investigation we conducted to evaluate the relative effectiveness of different methods of application of root inoculum, we compared the effectiveness of four methods and observed that placement of inoculum 2 inches below the soil surface was the most effective approach (Figure 10). However, although this effect was statistically significant, the differences did not appear to be of appreciable practical significance. Which technique to use is likely to be dictated by the type of inoculum being used, the quantity available, whether the inoculum is applied to pots or to a field, and the value of the crop. Placement of inoculum below the seed is perhaps the most versatile technique, being suited to both root and crude inocula and to greenhouse and field applications. That is probably why it is the most commonly chosen method of inoculum application.⁽⁶⁰⁾

Amount of inoculum to apply

The amount of inoculum to apply directly to soil is dependent on the quality of the inoculum. If a crude inoculum contains four to eight infective propagules per gram, application of 50 g/kg soil usually produces rapid initiation of AMF colonization of target plants with a minimal lag period. (See Appendix 7 for the procedure for determining the number of infective propagules in any material containing AMF.) Root inocula are generally more effective in stimulating plant growth in quantities substantially lower than are normal for crude inocula. Our investigations (MH, unpublished data) showed that if root inoculum contains 4000 cm of infected root per gram, application of 0.5–1 g/kg of medium produced good results.

Figure 10. Three ways to evaluate effectiveness of root inoculum application methods.

Means followed by the same letter are not significantly different at the 5% level (MH and M. Byappanahalli, unpublished data).

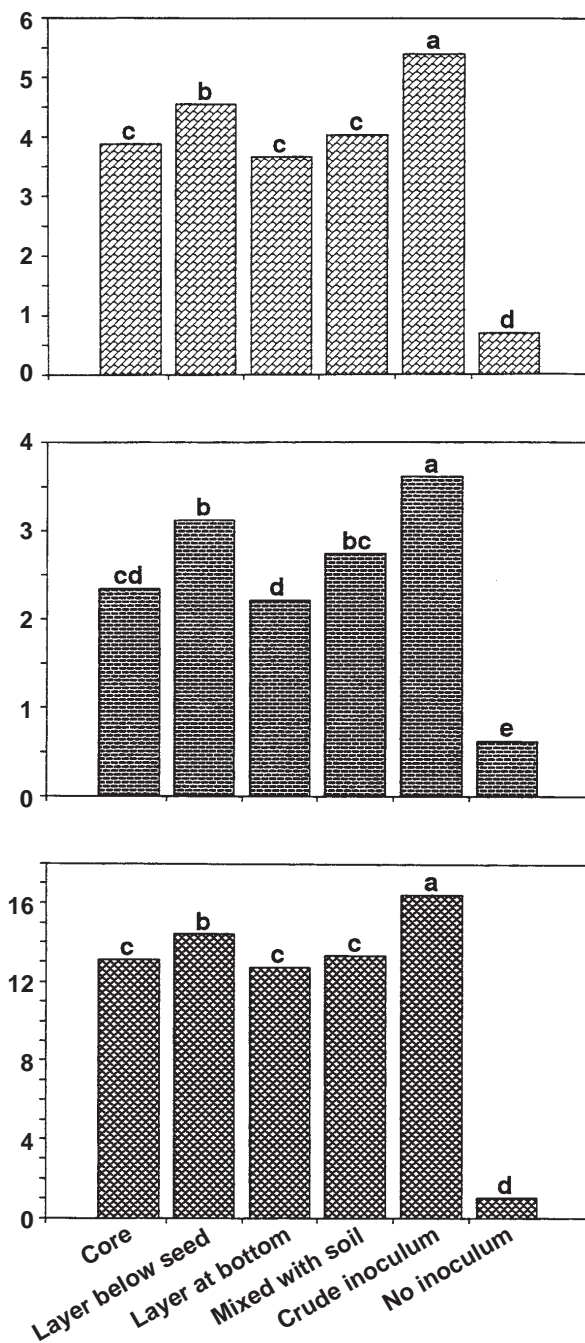

Evaluating effectiveness of AMF inoculum

One way to assess the quality of an inoculum is to determine the density of viable spores it contains (see Appendix 2). But a better way is to determine the total number of infective propagules in the inoculum. This can be done by employing the most-probable-number technique (see Appendix 7).

The quality of inoculum can also be assessed in terms of the degree and the speed with which the inoculum colonizes roots of an indicator species or stimulates the P uptake and growth of a highly mycorrhizal-dependent indicator plant species grown on a medium optimized for AMF activity. The rate of development of AMF colonization can be determined by growing the indicator plant in a medium optimized for mycorrhizal activity in the presence of the test inoculum and then monitoring AMF colonization of roots as a function of time through destructive sampling of roots. Growth of the indicator plant can be monitored over time nondestructively by measuring leaf number, plant height, stem diameter, and leaf-area index, or by destructively determining biomass accumulation. The P status of the indicator plant can be used to assess inoculum quality by growing the plant in the presence and absence of the test inoculum in a medium optimized for mycorrhizal formation and activity. P status can be determined nondestructively over time by monitoring the P content of pinnules (Appendix 8), leaf disks,⁽³⁾ or leaf tips,⁽⁴³⁾ depending on the species of the indicator plant used. The indicator plant routinely used in our program for this purpose is *Leucaena leucocephala* grown in a 1:1 soil-mansand mixture at pH 6.2–6.5 and a soil-solution P concentration of 0.01–0.02 mg/L (see Appendix 9 for a method for establishing the soil solution P concentration). Other nutrients are supplemented as described by Aziz and Habte⁽⁴⁾ (see the *Nutrient management* section under *Producing crude inoculum*).

Raising mycorrhizal seedlings

Most of the methods of AM fungi inoculum application discussed above can be readily used under greenhouse conditions and in experimental plots, but the requirement for labor and the huge quantity of inoculum required makes them impractical for application on extensive areas of land. The best approach for apply-

ing AMF inoculum, at least for species of plants that normally are transplanted, is to make sure the seedlings are well colonized by AM fungi in the nursery before they are transplanted to the field. Thus hundreds of mycorrhizal seedlings can be raised in relatively small areas of nursery for subsequent outplanting to large areas of land.

Seedling production as currently practiced in many nurseries will have to be modified appreciably if AMF technology is to be effectively integrated into the operation. The prevalent seedling production practices are based on organic media (peat), excessive watering, and very high fertilizer application levels, all of which are unfavorable to the initiation and development of the arbuscular mycorrhizal association. While peat has several desirable properties for growing seedlings, namely its light weight, high water-holding capacity, and large air-filled pore spaces, it is not a good medium for AMF development and at best gives unpredictable results. Its major limitation as a mycorrhization medium is its low P adsorption capacity (P buffer, or P “fixation,” capacity).⁽⁸⁵⁾ This is a problem that is rarely encountered in soil-based media,⁽⁸³⁾ especially in Hawaii, where most soils have relatively high capacity for P adsorption. However, soil-based media are heavy and have relatively low water-holding capacity, characteristics that make them unsuited for the production of large numbers of seedlings.

When peat is mixed with a small quantity of soil having a high P adsorption capacity and the P concentration of the mixture is optimized for mycorrhizal activity, the medium becomes very conducive to the development of mycorrhizal seedlings. The aim is to impart to peat the necessary property without using too much soil, because the greater the quantity of soil used, the less acceptable the method will be to nursery operators. Best results are obtained by mixing peat and soil at a ratio of 3 parts by weight of peat to 1 part of soil, adjusting the pH of the medium to 6.0–6.2 and the solution P concentration to 0.2–0.4 mg/L (Figure 11). Other nutrients can be supplied in the form of P-free Hoagland’s solution at the rate of 320 mL/kg of medium per week.⁽⁸⁵⁾ A comparable result can be obtained by amending the soil-peat mixture with a slow-release fertilizer (e.g., 19-6-12 with a 3–4-month release period) at 12–24 g/kg of medium, depending on the mycorrhizal dependency of the plant, and adding micronutrients as Micromax[®] at 0.53 g/kg (S. M. Peters and MH, unpublished data).

Figure 11. Pinnule P concentration of *Leucaena leucocephala* grown with and without AM fungi inoculum at five levels of solution P in the medium.

Plants were grown in peat-based medium in containers. Vertical bars represent LSD 0.05 (Peters and Habte 2001).

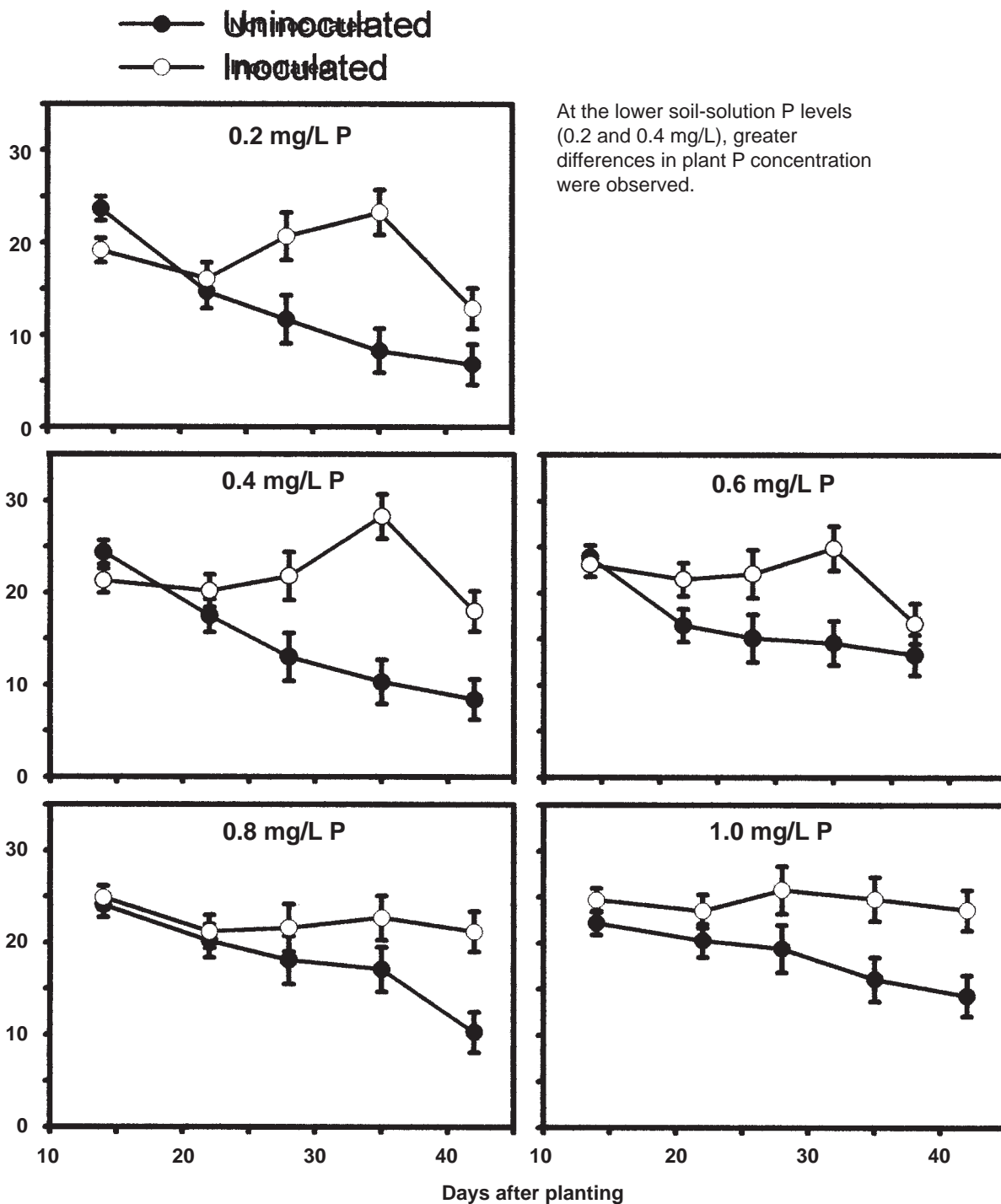
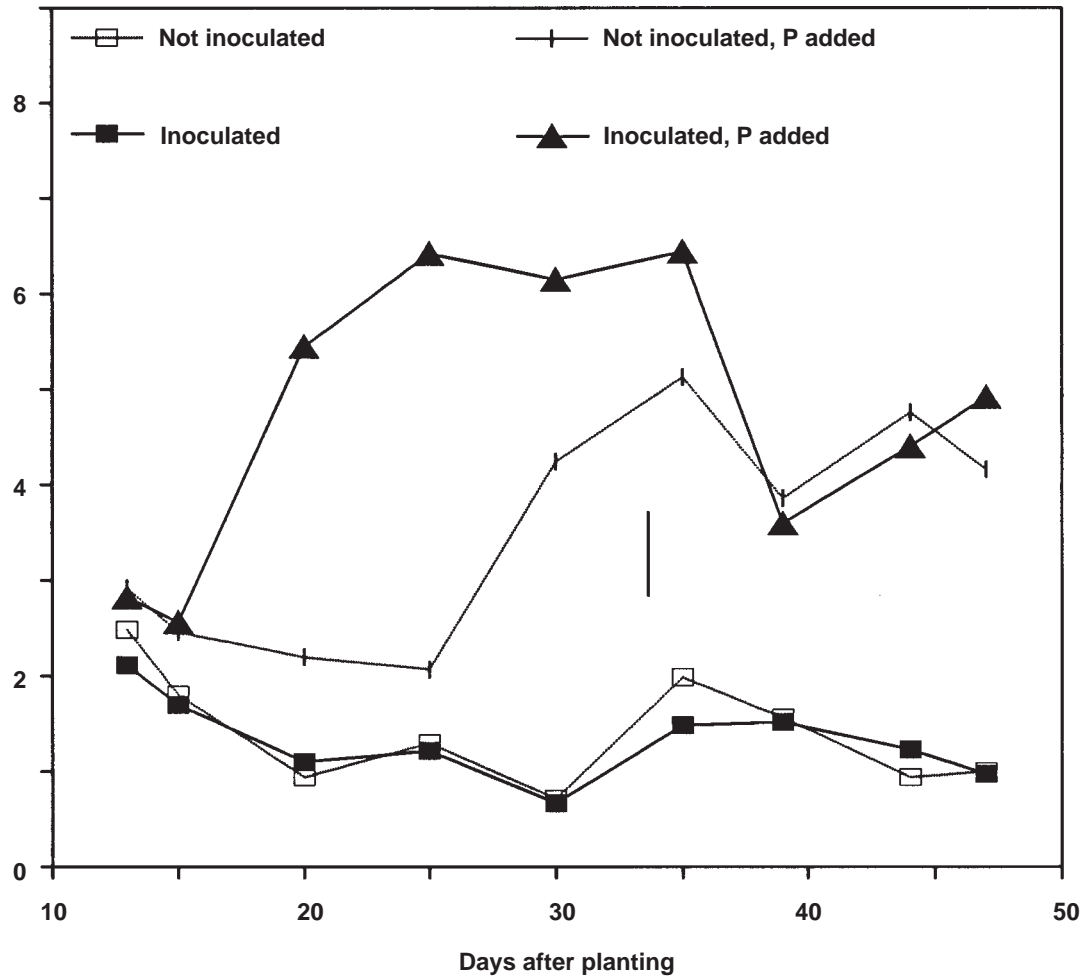

Figure 12. The effect of P optimization on the effectiveness of native and introduced AM fungi in the Kapaa soil (Typic Gibbsiorthox).⁽⁴⁰⁾

Without additions of P to this soil, neither native nor introduced AM fungi had an effect on plant P uptake, as evidenced by the lower two sets of data.



Factors influencing the AMF inoculation effect

The degree to which mycorrhizal fungi enhance the nutrition and health of associated plants depends on many biotic and abiotic soil factors, as well as other environmental factors that influence the host, the fungi, and their association. An exhaustive treatment of factors that influence the outcome of AMF inoculation is beyond the scope of this publication. But we will briefly discuss the most important factors involved, namely

abundance of AMF infective propagules, soil P status, variation in the degree to which target plant species rely on the mycorrhizal condition at the prevailing soil-solution P concentration, and soil treatment, including the type of previous crop or native vegetation.

Abundance of AMF propagules

Effectiveness of mycorrhizal fungi may not be rapidly expressed if the number of infective propagules contained in an inoculum is low. Many instances of poor inoculum performance may in fact be a result of a low

level of infective propagules. All other things being equal, if high-quality inoculum is introduced into a soil containing a very low density of indigenous AMF fungi, the probability of obtaining a positive response to inoculation is high.⁽⁴⁰⁾ However, if the soil contains high levels of infective propagules to begin with, it is unlikely that plants will respond to additional inoculation. It is, therefore, important to know about the quality of the inoculum as well as the abundance of native AM fungi in the target soil before one attempts AMF inoculation. Low-P soils that normally are fumigated to suppress pest population have very few or no AMF propagules. Plants grown on these soils will respond to AMF inoculation if the solution P concentration of the soil remains at a level insufficient for growth of nonmycorrhizal plants.

Soil P status

There are critical ranges of soil-solution P concentration at which the host-fungus association is truly mutualistic, i.e., where the benefit each partner derives from the association outweighs the costs.⁽²⁷⁾ The primary cost of the association to the host is the photosynthate that it provides for the maintenance and reproduction of the fungus.^(1,27) Under normal conditions, this expenditure is more than compensated by enhanced rate of photosynthesis resulting from an increased leaf area index⁽⁴⁸⁾ and perhaps also enhanced chlorophyll levels⁽¹⁰³⁾ induced by the mycorrhizal association.

As the soil P concentration approaches a level nearly adequate for mycorrhiza-free growth of the plant, the contribution of the AM fungi to plant productivity becomes negligible and may even be detrimental.

Mycorrhizal inoculation will have its maximum effect on plant growth at soil P concentrations near-optimal for mycorrhizal activity or at soil P concentrations that are barely accessible to the unaided root. This P concentration is host-dependent. The optimal soil-solution P concentration at which a balance between the fungus and host is maintained for fast growing, coarse rooted plant species like *Leucaena leucocephala* is 0.02 mg/L.⁽⁴¹⁾ At this concentration of soil P, the mycorrhizal association more than compensates the host for the cost associated with supporting the fungus. If phosphorus concentration in the soil solution is sub-optimal for mycorrhizal function, AMF symbiotic effectiveness is curtailed (Figure 12), and the fungus and the host may compete for scarce P. When solution P concentration is much above the optimum for a given

host-fungus combination, mycorrhizal colonization will be suppressed^(69, 91, 95) (Figure 7). If the host fails to suppress the development of the fungus at soil P concentrations near-optimal or above-optimal for mycorrhiza-free growth, the fungus will act as a parasite rather than a mutualist, and host growth may be depressed as a result.^(48, 64) The best approach to optimizing the soil solution P concentration is first to determine the P-sorption isotherm of the soil (Appendix 9)

The mechanism by which the host plant deals with imbalances caused by elevated concentrations of P is not well understood, but it appears to be related to photosynthate transfer. At high plant-P concentration, the host plant cell membrane is more stable and releases little or no root exudate into the rhizosphere, thereby reducing the level of AMF root colonization.^(37, 89) In contrast, increased root exudation by plants with internal P concentration deficient for mycorrhiza-free growth stimulates AMF colonization of roots until P concentration is sufficiently elevated to reduce leakage of exudates again.⁽⁴⁸⁾ It is clear, therefore, that the many benefits associated with inoculation with AMF will not be realized unless the soil-solution P concentration is optimal or near-optimal for AMF colonization and function. Consequently, AMF play crucial roles in certain conditions:

- native ecosystems (e.g., forests) where applications of large quantities of fertilizer P to extensive land areas is not usually done or is not practical
- agricultural systems on soils with strong P-fixing capacity, or where P fertilizer is unavailable or prohibitively expensive
- situations where it is essential to reduce soil fertilizer applications because of environmental concerns such as nutrient pollution of surface waters
- situations in which rock phosphate is readily available and used instead of more soluble P sources.

Variation in the dependence of plants on AM fungi

Mycorrhizal dependency is a measure of the degree to which a plant species relies on the mycorrhizal condition for nutrient uptake and growth as the concentration of P in the soil solution is increased. It is well established that plant species and cultivars within a given species vary in their response to AMF colonization.^(87, 88, 51, 66) Most of the variation may have to do with the ability of plant species to take up P at very low soil-P concentrations in the absence of mycorrhizal fungi.⁽⁵⁾

^{33, 75)} This property of P uptake efficiency, as discussed earlier, is related to a great extent to root mass and root morphology. Species that produce large quantities of fine roots and many long root hairs generally tend to be less responsive to AMF inoculation than those with sparse and coarse root systems and few root hairs.^(5, 14, 42) Other properties, as discussed previously, that allow some plants to have a low external P requirement and hence a low response to AMF colonization are the ability to acidify the rhizosphere or excrete chelating agents that bind to P-fixing cations like aluminum.^(31, 10) The degree to which these morphological and biochemical root mechanisms meet the host plant's demand for P will determine the degree to which the plant responds to AMF inoculation at a given soil-solution P concentration.⁽⁶⁷⁾

The first formal definition of role of AM fungi in plant nutrient uptake and growth was made in 1975 by Gerdemann, who stated that the dependency of plant species on the mycorrhizal condition is a function of soil fertility.⁽³³⁾ This definition has since been modified to make it more operational by replacing the imprecise term "soil fertility" with "soil solution P concentration."⁽⁴²⁾ All other things being equal, AMF inoculation will have its maximum effect on host plant growth when the level of P in the soil solution is barely accessible to a nonmycorrhizal plant. Because the effect of mycorrhizal colonization on host plants, by and large, could be duplicated by amendment of the soil with fertilizer P, one could establish categories of mycorrhizal dependency of host plants by assessing plant host responses to AMF colonization at different soil solution P concentrations.⁽⁴²⁾

When soil solution P concentration is appreciably lower than 0.02 mg/L, most plant species will respond dramatically to mycorrhizal colonization. As P concentration is increased from this level to 0.1–0.2 mg/L, the dependency of plants on AMF for P uptake diminishes progressively, so that at 0.2 mg/L only very highly mycorrhizal-dependent species respond significantly to mycorrhizal colonization.

Soil disturbance

The activities of AM fungi can be severely curtailed by soil disturbance in both native and agricultural ecosystems. In native ecosystems, soil disturbances caused by land clearing and mining operations can be so severe that mere inoculation of the affected areas with AMF may not be able to restore the symbiotic function

of the fungi.^(46, 96) The impacts of disturbances that have been studied in agricultural ecosystems are generally less drastic.⁽⁷⁷⁾ On the other hand, the activities of AMF are known to be adversely impacted even by disturbance events such as mechanical planting operations in otherwise undisturbed soils.⁽⁷²⁾ Numerous investigations have been undertaken over the past 15 years with the intent of understanding the mechanisms by which soil disturbance hampers AMF development and function. Soil disturbance due to tillage can adversely influence the abundance and diversity of AMF (Figure 13), but data on the subject is very scant at present. Nevertheless, there is evidence to indicate that the diversity of AMF communities tends to decline upon the conversion of native ecosystems into agricultural ecosystems and with the intensification of agricultural inputs.⁽⁶³⁾ Pot studies involving the use of split compartments separated from each other by sealed nylon meshes have clearly demonstrated that tillage suppresses the effectiveness of AMF by destroying the extraradical hyphal network that develops in soil in association with the previous mycorrhizal crop.^(24, 62, 65) In no-till and reduced-tillage systems, maintenance of the integrity of this hyphal network contributes to more rapid AMF infectivity and more efficient nutrient uptake than is possible in more severely disturbed soils. In soils severely disturbed by tillage, the native AMF populations are not likely to initiate AMF formation on the target crop rapidly, and the process can be enhanced by inoculating the soil with high-quality AMF inoculum.

Impacts of fallowing or a previous nonmycorrhizal crop

Because AMF are obligate symbionts (requiring a host to persist), they are sensitive to cultural practices that hamper or delay their contact with appropriate host species. Within the context of cropping systems, conditions likely to adversely influence the efficacy of the fungi in the ecosystem include a fallow period, a cropping sequence that includes a nonmycorrhizal plant species, or a non-ideal AMF species.⁽⁶⁰⁾ In Australia, a phenomenon known as long-fallow disorder adversely affects many crops, including wheat, sorghum, and soybean. The problem is correlated with declines in the density of AMF propagules in the soil during the fallow periods.⁽⁶³⁾ Reduction in AMF abundance and activity also result because of the inclusion of

Figure 13. The impact of simulated erosion on the abundance of AMF infective propagules in the Wahiawa soil.

Means followed by the same letter are not significantly different from each other at the 5% level.⁽³⁸⁾

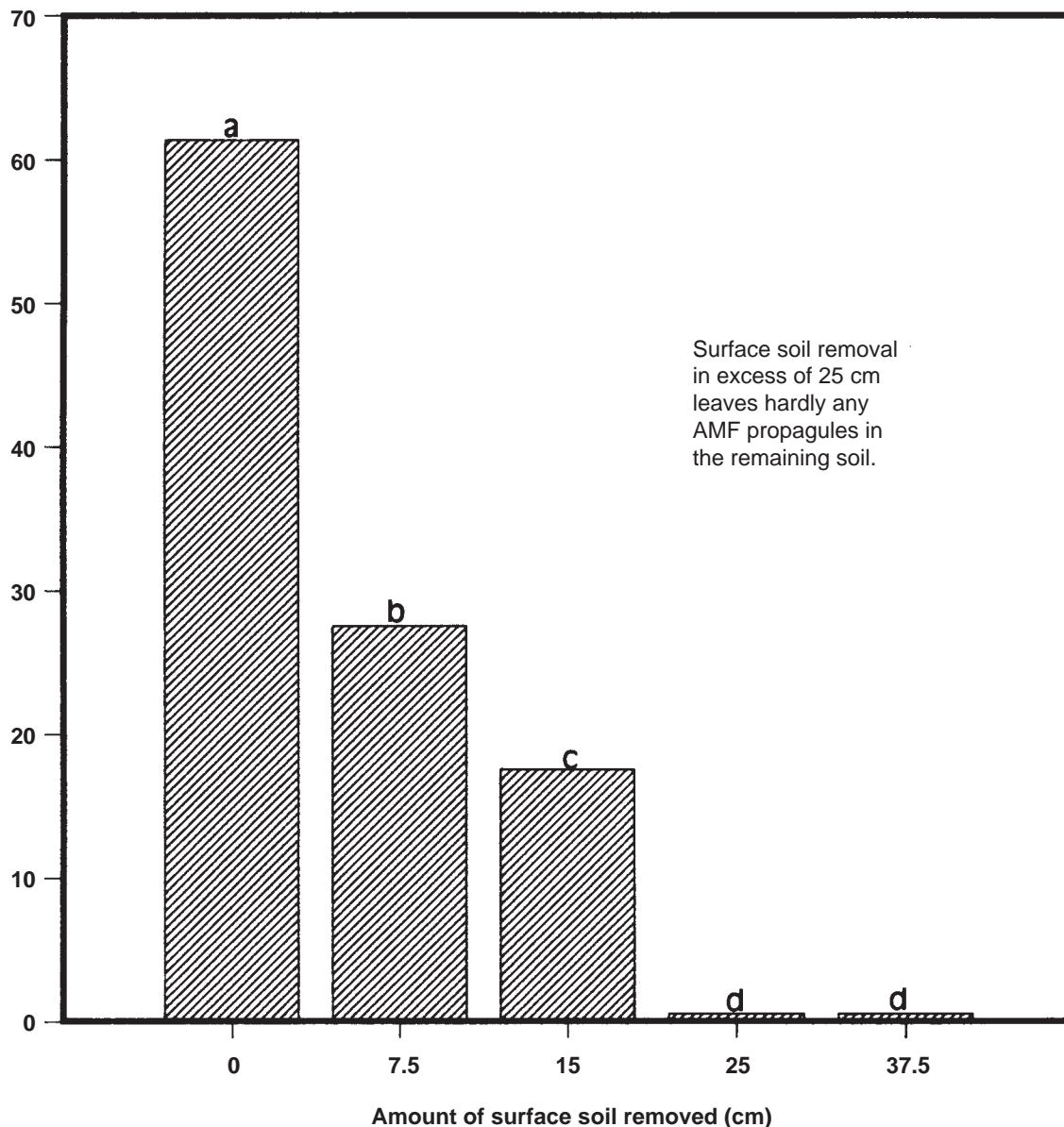

nonmycorrhizal or poorly mycorrhizal plant species in a cropping system. For example marked reduction in AMF colonization of maize roots have been noted following a nonmycorrhizal canola crop vs. a previous maize crop.⁽³²⁾ One way of offsetting this type of detri-

mental effects is through AMF inoculation. The adverse effects of a fallow period can also be minimized by planting soils with an appropriate mycorrhizal cover crop species to ensure build-up of AMF propagules for the subsequent crop.⁽¹¹⁾

Appendix 1.

Extracting AMF spores from soil or crude inoculum

Background

Arbuscular mycorrhizal fungi produce spores that are characteristic for each fungal species. The identity of AMF isolates can be established by means of spore characteristics such as size (10–1000 μm), color, surface texture, ornamentation, sub-cellular structures, anatomy of subtending hypha, and spore wall configuration.⁽⁹⁷⁾

Whenever possible, it is good to identify spores before they are used for starting an inoculum. The use of spores for starting mycorrhizal inoculum has several advantages. For instance, spores of undesired AMF species can be removed, spores can be easily counted, spore viability and germination can be evaluated, and presence of plant pathogens (e.g., nematodes) can be avoided.⁽²¹⁾

Procedure

Wet-sieving and decanting

Soil samples from field sites should be taken from the rhizosphere of mycorrhizal native or crop plants at a soil depth where the most root proliferation occurs, usually 0–20 cm.⁽²²⁾ The sample is then passed through a 2-mm sieve. A 100–200-g soil sample (dry weight) is transferred to a beaker. If the soil is dry at sampling, make sure it is soaked for 30–60 minutes before attempting to extract spores. Soil aggregates can be crushed with a spatula. Distilled or deionized water is added to obtain a 1-L suspension, and the suspension can be agitated for 1 hour in an electric stirrer. The purpose of these steps is to disperse the soil aggregates and release AMF spores. A 3.5% sodium hexametaphosphate solution can be added to increase soil dispersion. Spores are then extracted from the suspension as illustrated in Figure 14.

The soil suspension is poured through a stack of sieves (750, 250, 100, 53, and 37 μm), the finest sieve being at the bottom of the stack. A stream of tap water is added to facilitate the movement of spores. If a nest of sieves is used, care must be taken to ensure that sievings are not lost due to overflow. The material that

remains in the 37-, 100-, and 250- μm aperture sieves is suspended in water and transferred to centrifuge tubes and centrifuged for 3 minutes at 2000 g. Spores are sedimented at the bottom of the tube, while organic materials remains in suspension. After removing the supernatant, the sediment is re-suspended in a 50% sucrose solution and centrifuged again for 1–2 minutes at 2000 g. After this, the spores will be in the supernatant or in the sugar-water interface. The supernatant fluid containing the spores is poured onto a 28- μm aperture sieve or removed with a syringe and rinsed immediately with water to remove the sucrose. Exposure of spores to high concentration of sugar for too much time can dehydrate them, and therefore they should be transferred to tubes and stored in distilled water at least for 24 hours before mixing them with the growth medium. This will allow them to overcome osmotic shock.⁽⁵⁷⁾

The number of AMF spores in a suspension can be determined under a microscope by transferring a small volume of the suspension into a counting chamber such as the type used for counting nematodes. The standard counting chambers used in microbiological laboratories are etched with squares of known area and are constructed so that a film of the suspension of known depth can be introduced between the slide and the cover slip.

Separation into morphotypes

Spores of AMF can be transferred to a petri dish for microscopic examination and separation. Spores can be separated into distinct morphological types (Figure 15) using the criteria mentioned previously in this section. Fine-tipped forceps or Pasteur pipettes can be used to transfer spores into vials or micro-dishes with water for subsequent evaluation and identification. Alternatively, spores can be collected on a filter paper and picked up from it singly with forceps or a fine-tipped instrument such as a dissecting needle or a paint brush. Collection of spores from water suspension is better for avoiding undesired hyphal fragments.

Identification of AMF spores is a difficult and time-consuming exercise for most researchers in the field.

Figure 14. AMF spore extraction from soil by wet-sieving and decanting. (adapted from Mark Brundrett⁽¹⁴⁾)

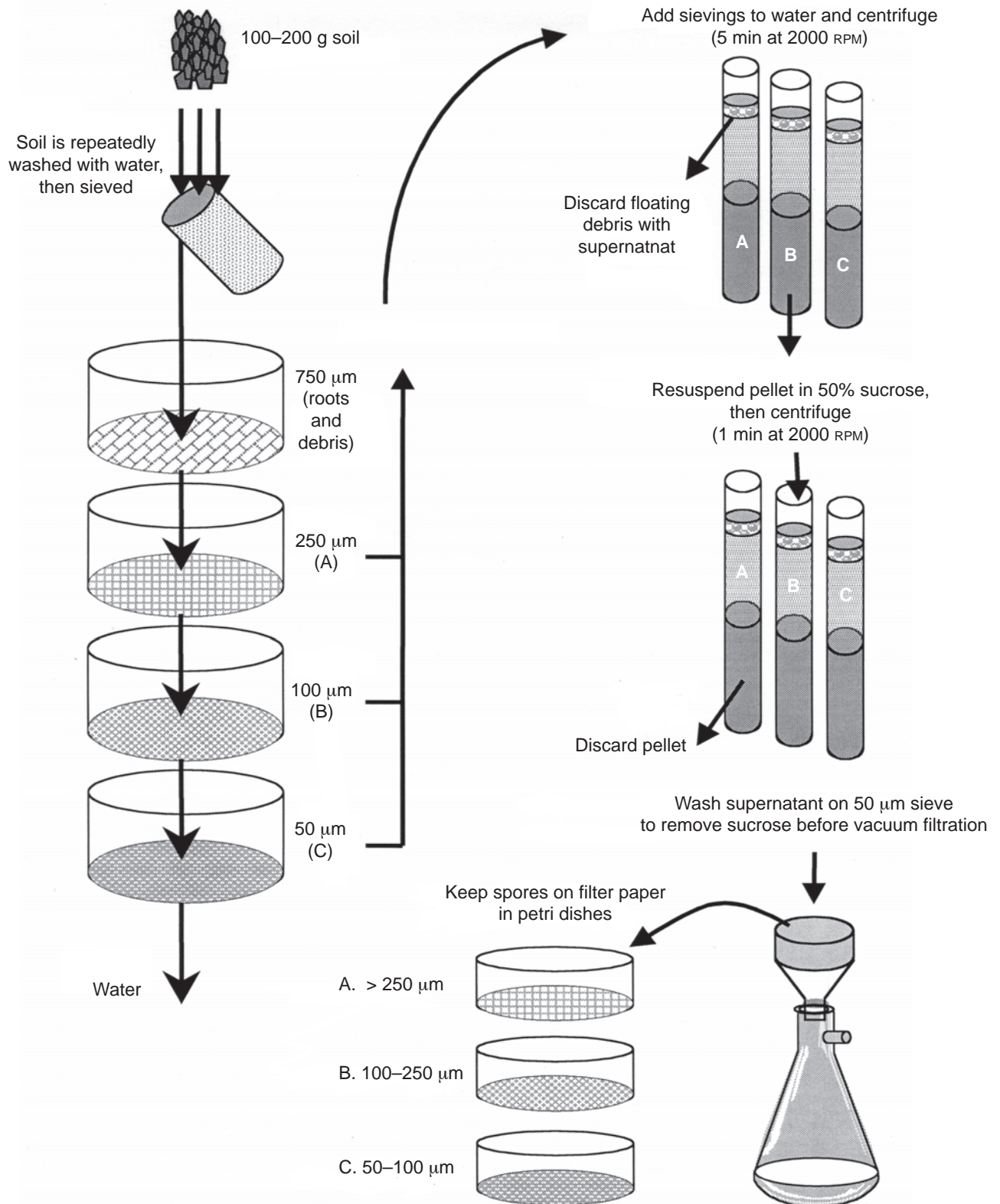
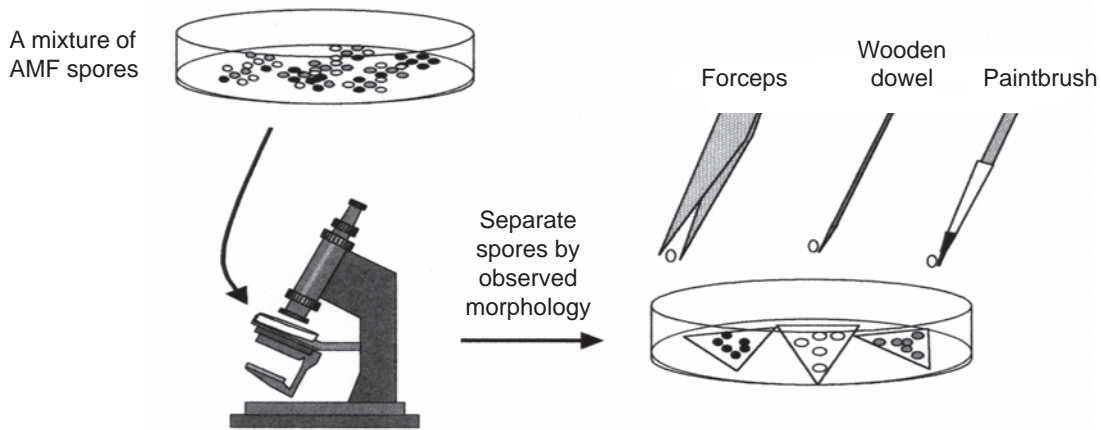

Figure 15. Separation of AMF spores into morphological groupings after extraction from soil.
(adapted from Mark Brundrett⁽¹⁴⁾)



We believe it is cost-effective for most of us to send purified isolates to colleagues whose focus is on AMF taxonomy, or to organizations such as INVAM⁽⁵⁷⁾ or the European Bank of Glomales,⁽⁷⁾ which in most instances are willing to identify spores freely or at cost. Once spores are isolated and identified, they can be surface-disinfected and used as a starter inoculum for production of inoculum in one of the several ways described already. Spores of AMF are surface-sterilized by exposing them to a solution of liquid detergent (e.g., Tween 20), 0.5% sodium hypochlorite, or 2% Chloram-

ine T, and 0.02% streptomycin sulfate⁽⁶³⁾ in a filter unit allowing contact for 15 minutes and then rinsing with five changes of water. Alternatively, spores can be exposed to 0.01–1% mercuric chloride for 2–10 minutes⁽⁸⁹⁾ and rinsed with three to five changes of sterile distilled or deionized water. If mercuric chloride is used, the spent solution should be carefully collected, stored in appropriately labeled containers, and disposed of in a safe manner according to appropriate local toxic waste disposal procedures.

Appendix 2.

Extracting spores from a crude inoculum and determining their viability

This procedure (see Figure 16) is similar to that described in Appendix 1 except that separation of spores and their identification may not be required when the spores are extracted from a crude inoculum of a known isolate unless, of course, the crude inoculum was started with a mixture of known species.

Background

After spores of AM fungi have been isolated from soil or inoculum, their germination should be assessed. Commonly, not all the spores of AMF are ready to germinate and infect host plants. This is because spores exhibit a stage of dormancy in which they do not germinate until conditions for growth and development are favorable. However, some spores are unable to germinate even under favorable conditions, a phenomenon known as innate dormancy. It can persist for a few days to months. Innate dormancy can be overcome by treatments such as slow drying, cold treatment at 4°C, or soaking in water.

Procedure

The procedure described below is an adaptation of that described by Brundrett and Juniper.⁽¹²⁾ Sterilized soil or sand-soil mixture containing a very low concentra-

tion of available P is aseptically packed in a petri dish, leveled, and moistened with distilled water or a solution of 0.1% trypan blue to maximum available water-holding capacity (Figure 17). The trypan blue solution facilitates the visibility of hyphae. On the surface of the soil, a nylon mesh (pore size 50 µm) is placed. Pieces of membrane filter 10 x 10 mm (cellulose-acetate, Millipore™, pore size 0.45 µm) are placed on the nylon membrane. The nylon mesh and filter squares should be sterilized by immersion for 5 minutes in 70% ethanol and rinsed with sterile deionized or distilled water prior to use. One AMF spore is placed on each filter square. The petri dish is covered and incubated in the dark at 20°C and observed regularly under a stereo microscope for 5–20 days, depending on the AMF species involved.

A spore is considered to have germinated when the length of the germ tube exceeds the diameter of the spore. Except during observation for germination, the petri dish must remain closed to avoid desiccation or contamination.

Alternatively, spores can be placed on a membrane filter that is folded twice and inserted into moist soil. After a 2-week incubation period, the filter is removed, unfolded, stained, and examined under a microscope.⁽⁵⁶⁾

Figure 16. Spore extraction from crude inoculum.

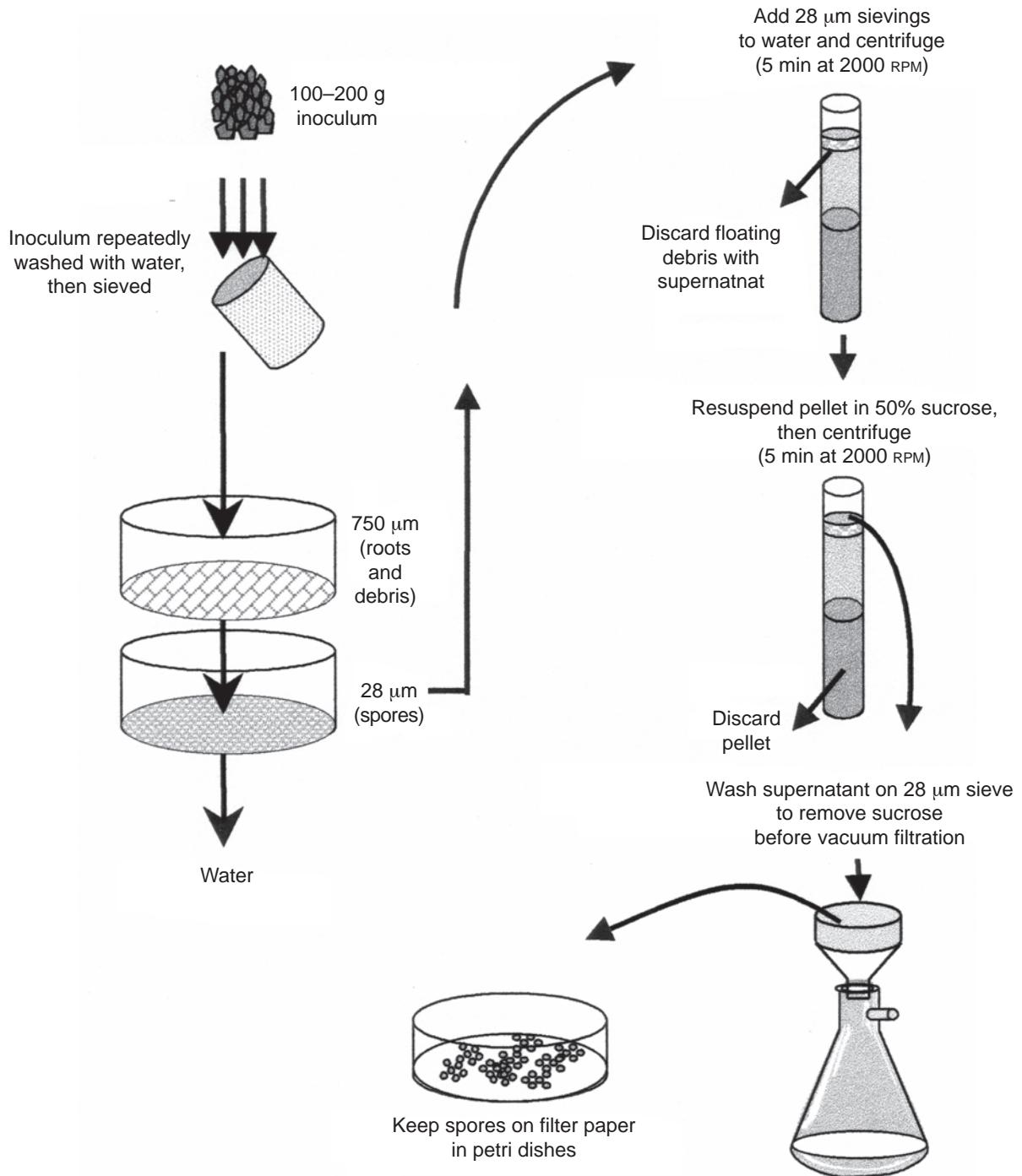

Appendix 3.

A modified Hoagland's solution II⁽⁵²⁾ for use in AMF inoculum production

Stock solution	Working solution (ml/L of stock solution)
MNH_4NO_3	1
$MKNO_3$	6
$MCa(NO_3)_2$	4
$MMgSO_4$	2

Micronutrient solution

Dissolve the indicated amounts in 1 liter of deionized water; 1 mL of this solution is added to each liter of final solution.

Element	Carrier	Amount (g)
B	H_3BO_3	2.86
Mn	$MnCl_2 \cdot 4H_2O$	1.81
Zn	$ZnSO_4$	0.22
Cu	$CuSO_4 \cdot 7H_2O$	0.08
Mo	$H_2MoO_4 \cdot H_2O$	0.02

A separate iron solution

Prepare a 5% iron tartrate solution and add it at the rate of 1.0 mL/L of final solution just before the solution is added to the plant.

Figure 17. Diagram illustrating the determination of AMF spore viability.

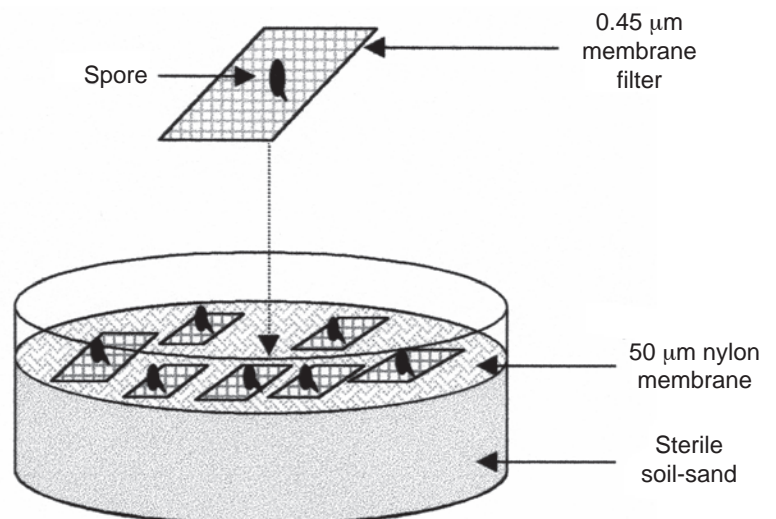

Appendix 4.

Hydroponic production of AMF inoculum

Arbuscular mycorrhizal inoculum can be produced hydroponically (Figure 18), whereby roots of plants supported on a solid medium or structure are submerged in a reservoir of a nutrient solution such as dilute Hoagland's solution (Appendix 3) or Hewitt's solution with low phosphorus concentration.⁽⁷⁸⁾ Full-strength Hewitt's solution⁽¹⁰⁰⁾ consists of (mg/L) Ca 160, K 156, N 114 (NO₃ 50–100%), S 112 or 240, P 41, Mg 36, Na 246 or 62, Cl 284, Fe 2.8, Mn 0.55, B 0.33, Zn 0.065, Cu 0.015, Mo 0.015, Co 0.015. The solid structure or band of substratum supporting the plant can be sterile silica sand, perlite (2–3 mm in diameter), or a similar material.

Seedlings of nurse plants such as maize, wheat, or any other suitable mycorrhizal plant are precolonized by an AMF and transplanted in the support medium or structure. The roots of the plant grow through the band of support structure or medium into a nutrient reservoir. Air is continuously bubbled throughout the solution. The nutrient solution is changed at regular intervals. In a submerged sand system, it is necessary to change the medium at an interval of 3–4 days⁽¹⁰⁰⁾. Distilled or deionized water is added to the reservoir as needed.

Nine to ten weeks after transplanting, plant tops are cut and roots recovered from the reservoir, processed as needed, and either used immediately or stored for use at a later time. Alternatively, mycorrhizal roots can be produced by growing suitable nurse plants in a sand matrix submerged in a nutrient solution conducive for mycorrhizal development. Best results are obtained by using a low-strength (0.1–0.25) nutrient solution with a low P concentration. In addition, NO₃-rich solutions are preferred over NH₄-rich solutions because high NH₄ concentrations lower the pH of the solution, reducing plant growth, AMF colonization, and spore production.⁽¹⁰⁰⁾ After 9–10 weeks of growth, the shoot is removed and the root in the sand matrix is harvested. Washings of the sand can be passed through a sieve with 63 µm diameter pores in order to recover AMF propagules that might not have been removed with the root system.⁽¹⁰⁰⁾ Fine roots are sampled and examined for mycorrhizal colonization.

Nutrient film technique

The nutrient film technique is a modification of the hydroponic technique. Mycorrhizal plants are grown in a channel in which a thin film of nutrient solution is circulated around the root system^(54, 55) (Figure 19). Seedlings precolonized by AMF are transplanted and grown with a 0.1 strength Hoagland's solution (formulation given in Appendix 3) circulating at the rate of 1 L/min. The considerations about N source, pH, and low phosphorus concentration (<0.1 mg/L P) highlighted in the preceding paragraph are applicable here too.

After 4 months of growth, roots are gently removed and cut to 1-cm length. These root fragments are examined for mycorrhizal colonization and presence of spores. Root fragments can be used as mycorrhizal inoculum and, if desired, AMF spores can be removed by washing them over a two-sieve nest (750 and 50 µm). The roots are collected in the coarser sieve, while the spores are collected in the finer sieve.

Howeler et al.^(54, 55) grew plants in a nutrient film culture with various concentrations of phosphorus circulating at 1.6 L/min. They found mycorrhizal colonization in eight cultivars of cassava, rice, maize, cowpea, and bean at P concentration of 0.1 and 1.0 µM (0.0031 and 0.03 mg/L, respectively) but not at 10 and 100 µM. Fungal mycelium around roots was visible to the naked eye, and there were spores in the mycelial mass that could also be used as inoculum.

Elmes et al.⁽²³⁾ used finely ground rock phosphate as a source of P and applied it at the rate of 0.1 mg/L in order to produce AMF inoculum using the nutrient film technique. The host plant was bean (*Phaseolus vulgaris*) and the fungus was *Glomus fasciculatum*. The pH of the solution was adjusted to 6.5 as needed. After 22 weeks of growth, a mycorrhizal colonization level of 80% was observed, and the roots were harvested, cut into 1-cm lengths, mixed with sterile sand, and tested in a field experiment at an inoculum application rate of 6 and 42 g/m² of fresh roots. The application rate using roots was less than that used with soil inoculum, and the mycorrhizal roots grown with the nutrient film technique were as effective as AMF inoculum produced in sterile soil, sand, or soil-sand mix.

Figure 18. An apparatus for producing AMF inoculum hydroponically.

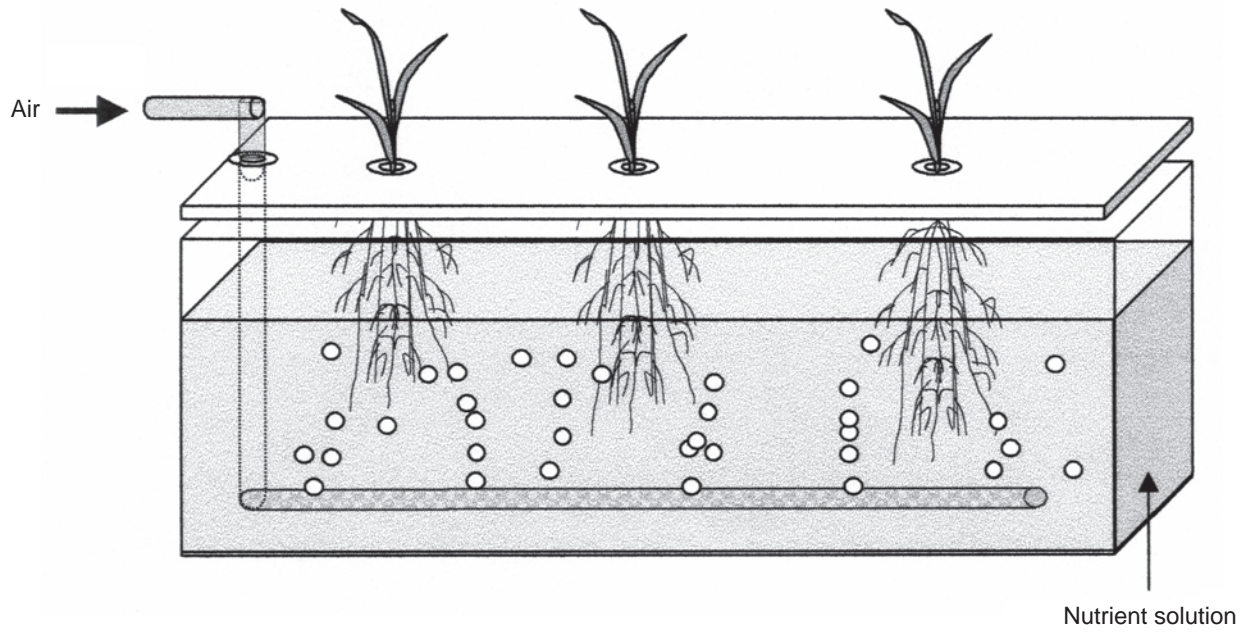
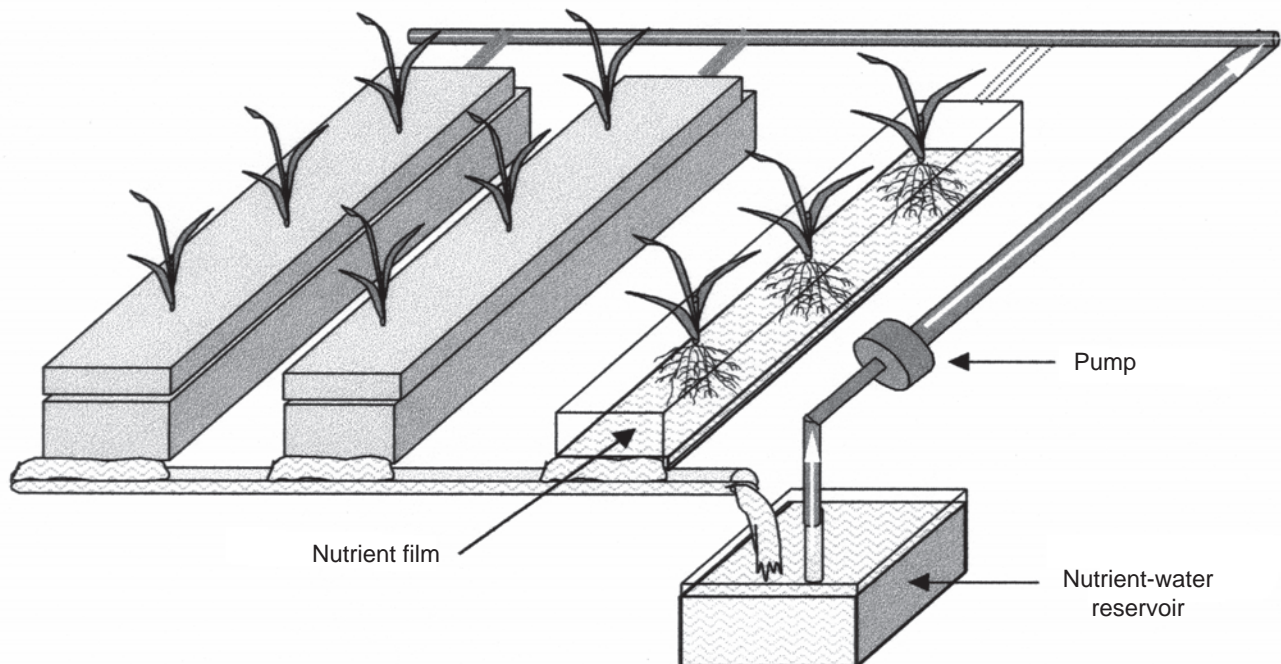

Figure 19. An apparatus for producing AMF inoculum by the nutrient film technique.



Appendix 5.

Aeroponic production of AMF inoculum

AMF inoculum can be produced from plants grown in chambers with their roots constantly exposed to a nutrient mist.^(56, 63) A nutrient solution held in a reservoir below the root system is propelled by a rotating impeller (Figure 20) or pressurized through nozzles. The solution is a low-P (0.03 mg/L),⁽⁵⁸⁾ dilute Hoagland's solution with an initial pH of 6.5, with pH frequently monitored and adjusted. Zobel et al.⁽¹⁰⁶⁾ recommended the use of one-eighth strength of Hoagland's solution after testing several plant species. The solution should be routinely renewed.

Host seeds (e.g., bahia grass, sweet corn, sorghum, Sudan grass) or cuttings (sweetpotato) are disinfected (30% H₂O₂, 10 min) and then inoculated with surface-sterilized spores of AMF. Host plants are grown for 6–8 weeks, after which time their roots are washed, examined for AMF colonization, and trimmed to 6–8 cm length. Only infected host plants are then transferred to the aeroponic chamber with 10–12 cm spacing between plants. Polyester fiber supports the plants.

Roots from host plants can be removed after 10–12 weeks of growth in the aeroponic chamber. Spores can be separated from the roots by washing over a sieve with $\leq 425 \mu\text{m}$ pores. The roots are either cut into 1-cm lengths and used directly as inoculum or processed further. The roots segments can also be suspended in water in a 1:10 ratio (fresh weight: volume), sheared in a food processor for 40 seconds to fragments $< 0.5 \text{ mm}$ long, and collected in a fine screen ($45 \mu\text{m}$) in order to maximize the inoculum density.⁽⁶³⁾ Dried roots are difficult to shear, but roots can be sheared after being stored at 4°C for less than three months.⁽⁹⁸⁾ Spores, root segments, and sheared roots can be mixed and used as inoculum.

Moist roots and spores can be stored in distilled water or sterilized, moist vermiculite at 4°C for 4–9 months.⁽⁵⁶⁾ Roots previously air-dried (21–25°C, 72 hours) can be stored in oven-dried vermiculite in the dark at 4°C for about 2 years; storage in moist vermiculite can be done for a short period of time (< 1 month).⁽⁹⁸⁾

Figure 20. A chamber for producing AMF inoculum aeroponically.

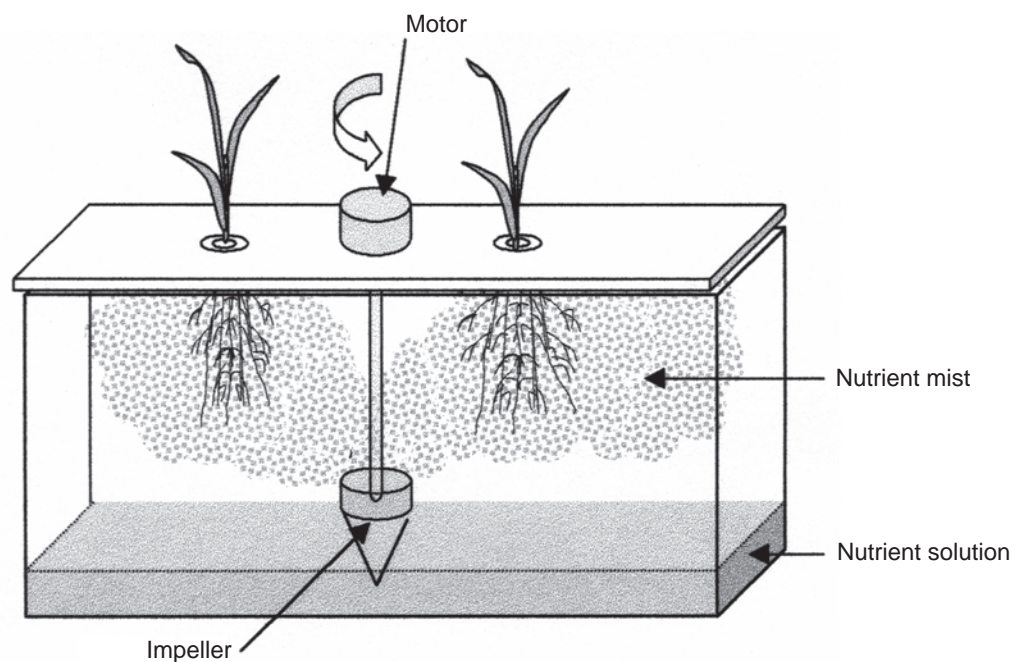

Appendix 6.

Detecting and quantifying AMF colonization of roots

Background

Arbuscular mycorrhizal fungal colonization of roots is not generally evident to the naked eye, and diagnostic features of the fungi can be discerned only under a stereo or compound microscope after roots are cleared (to remove the nuclear and cytoplasmic materials), acidified, and then stained in specific ways. Several procedures for staining roots for detecting and quantifying AMF fungi have been developed.^(13, 69, 70, 86) The procedure described below represents a modification of that described by Kormanik et al.⁽⁶⁹⁾ We have used the technique extensively for over 15 years with satisfactory results. We first became aware of this procedure when we wanted to abandon phenol and Trypan blue-based staining procedures for safety reasons (Trypan blue is a suspected carcinogen, and observation of roots stained with dyes dissolved in phenol induced headaches).

Procedure

Collecting root samples

After the root system is thoroughly washed free of soil, obtain a representative sample by removing four to five portions containing the entire length of the root. Chop the portions into four segments and mix them together. Transfer 0.2–0.5 g (moist weight) portions of the mixture into glass or plastic vials. Rinse the roots with a couple changes of water if needed. In studies involving slow growing plants or seedlings, the amount of root produced is so small that the whole root system can be stained and observed.

Clearing roots

The aim of clearing is to get rid of nuclear and cytoplasmic materials in order to facilitate maximal penetration of the stain. Clear roots by completely covering them with 10% KOH in de-ionized water (w/v) for 24–48 h at ambient temperature. Pour off the KOH solution and rinse the root in at least four changes of water. If roots are dark or pigmented, they can be bleached before they are acidified and stained. The most commonly used bleaching material is alkaline H₂O₂. It

is prepared by mixing 3 ml of NH₄OH with 10% H₂O₂ and 567 ml of tap water. NH₄OH may be replaced by the same volume of household ammonia. The duration of bleaching is 10–20 minutes, after which the roots are rinsed with at least three changes of tap water.

Acidifying roots

Roots must be acidified to facilitate retention of the stain by the target specimen. Cover the roots with 10% HCl for 5–10 minutes. Remove the acid but do not rinse the root after this step.

Staining roots

Cover roots with an acid fuchsin-lactic acid solution and incubate them at ambient temperature for 24–48 h. The staining solution is prepared by dissolving 1.5 g of acid fuchsin in a solvent consisting of 63 ml of glycerine, 63 ml of water, and 875 ml of food-grade lactic acid.

Destaining roots

To destain roots, decant the stain from the vials containing the roots and rinse the roots with used but filtered (Whatman #1 filter paper) destaining solution to get rid of the excess stain. Cover the roots with unused destaining solution which consists of the solvent mixture used for dissolving the dye. Incubate the vials at ambient temperature for 24–48 h. At the end of this period, decant the destaining solution and add unused destaining solution. The roots now should be ready for observation.

In each of the above steps in which incubation is involved, the 24–48-h incubation period can be replaced by heating in a water bath at 90°C for 1 h or autoclaving at 121°C for 15 min, if one has the means for doing so.

Observing stained roots and estimating AMF colonization level

Stained root fragments can be spread in petri plates or mounted on microscope slides and examined for the occurrence of typical AMF structures. The most accurate method of determining the level of infection is the grid line intersect method.⁽³⁴⁾ In this method, stained

root preparations are spread on petri plates with grid lines on the bottom (Figure 21). The roots are then examined under a stereo microscope at 40x magnification. Each intersection of root and gridline is checked for the presence or absence of AMF structure(s) and scored as colonized or not colonized by AMF. Using these values the percentage of AMF colonization can be calculated. In this technique, the grid lines simply serve to systematically locate points of observation. For best accuracy, at least 200 root-gridline intersects must be tallied, although 100 root-gridline intersects are acceptable in most instances. The method can also be used to estimate the proportion of the root length that is colonized by AMF. The number of root-gridline intersects to the total length of root spread is related by the formula,

$$R = \frac{\pi A n}{2H}$$

where

R = the total length of root

π = 3.1416

A = the area in which roots are distributed

n = the number of root-gridline intersections

H = the total length of straight lines.

For a more detailed discussion of the technique, see Giovannetti and Mosse.⁽³⁴⁾

Chemical safety precautions

Use rubber gloves during the preparation and use of the clearing, staining, and acidifying solutions. Collect used staining and destaining solutions in separate and labeled screw-capped bottles for recycling or disposal. Used KOH and HCL can be mixed together, further neutralized, and discarded in the sink.

Figure 21. Quantifying AMF colonization levels by means of the gridline intersect method.

In the plate depicted, there are a total of 27 intersections of roots with gridlines (both vertical and horizontal grid lines are considered). Of these, only 14 represent intersections of gridlines with AMF colonized roots. These values yield a percent root length infection of 52.

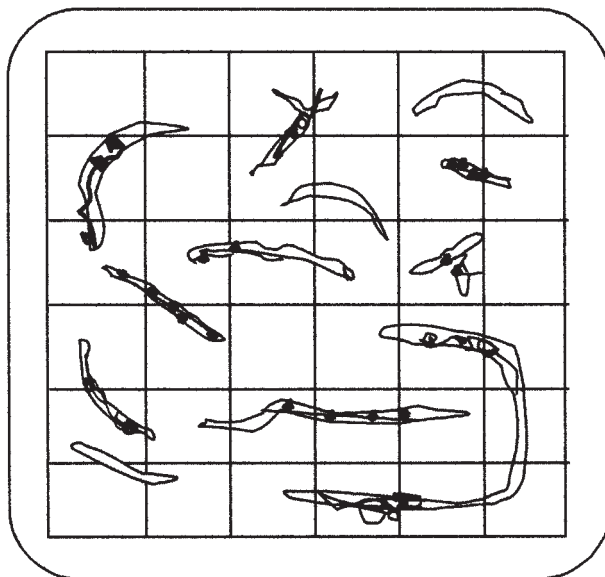

Appendix 7.

Determining the abundance of infective propagules in crude inoculum and in soil

Background

Determining the number of infective propagules in soil and crude inoculum can be complex for various reasons. First, fungal structures such as spores, vesicles, arbuscules, mycelium, and even colonized roots act as infective propagules. Secondly, AMF cannot be cultured under in vitro conditions apart from their host plants. Although spores can be isolated and counted, not all of them are ready to germinate, and hence spore numbers are often not strongly correlated with AMF infectivity. The most reliable method of assessing the number of infective AMF propagules contained in a crude inoculum, soil, or sheared mycorrhizal roots is the most-probable-number (MPN) technique,⁽²⁾ which permits a statistical estimation of microbial population density without a direct count of single cells or colonies. The MPN technique is the most precise method to estimate mycorrhizal propagule numbers because it considers the infectivity of viable spores, mycelial fragments, and fragments of colonized roots.

Procedures

The technique is based on determining the presence or absence of microorganisms in several individual aliquots of each of several consecutive dilutions of a sample of soil or other materials containing microbial propagules. A serial dilution, usually 10-fold, of a soil or crude inoculum sample is prepared using sterile sand, soil, or sand-soil mixture as the diluent. From each dilution, a predetermined amount of material, say 20 g, is used to inoculate each of five cups containing 270–350 g of sterile soil or sand-soil mixture optimized for mycorrhizal activity with a soil-solution P concentration of 0.02 mg/L.

Germinated seeds or seedlings of a suitable mycorrhizal plant (onion, clover, leucaena, etc.) are sown in these cups, which are placed in a reservoir containing water or P-free nutrient solution. The preceding steps are illustrated in Figure 22. In our program, the

indicator plant of choice for MPN determination is *Leucaena leucocephala*, and it is grown on a 1:1 mansand:soil mixture. The P concentration of the medium is 0.02 mg/L and its pH is 6.2. The medium is supplemented weekly with 100 mL of P-free Hoagland's solution (see Appendix 3). The plants are then allowed to grow in the greenhouse or growth chamber for four weeks. At the end of the growth period, the roots are excised, washed, cleared, and stained as described in Appendix 6. The stained roots are spread in a petri dish and scored for the presence or absence of AMF colonization. Do not count detached hyphae or germinated spores.

To calculate the most probable number of infective propagules in a sample, the statistical table developed by Cochran⁽¹⁷⁾ (Appendix 11) is essential. In the table, p_1 stands for the number of positive replicates in the least concentrated dilution, and p_2 and p_3 represent the numbers of positive replicates in the next two higher dilutions. The most probable number of infective propagules in the quantity of the original sample is obtained by multiplying the reciprocal of the middle dilution by the number in the table located at the point of intersection of the experimentally observed values corresponding to p_1 , p_2 , and p_3 . The value represents the most probable number of infective propagules for the quantity of soil used to inoculate test plants (20 g in the current example). The number of infective propagules per gram of soil can be obtained by dividing the number of infective propagules observed by the quantity of soil. Suppose the following number of positive replicates are obtained for the following dilutions:

$$10^{-1} = 5$$

$$10^{-2} = 4$$

$$10^{-3} = 1$$

$$10^{-4} = 0$$

$$10^{-5} = 0$$

In this series, $p_1 = 5$, $p_2 = 4$, and $p_3 = 1$.

Figure 22. Steps in the quantification of AMF infective propagules in soil samples or inoculum by the most-probable-number technique.

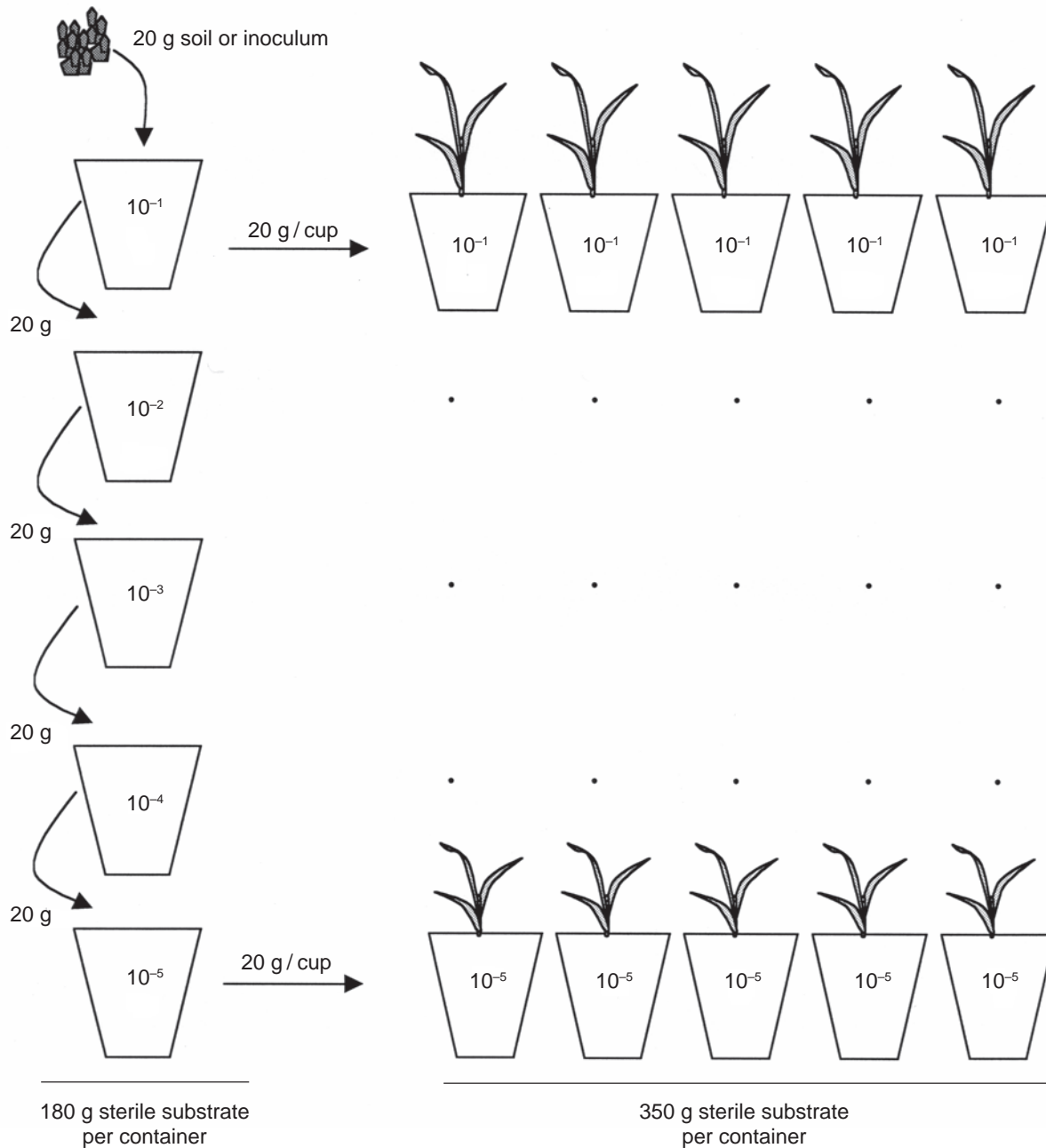

For this combination of p_1 , p_2 , and p_3 , Cochran's table gives 1.7 as the most probable number of infective propagules applied in the 10^{-2} dilution. Multiplying this value by the dilution factor 10^2 gives 107 as the num-

ber of infective propagules in the original sample. The number of infective propagules per gram of soil is calculated ($107 / 20 = 5.35$) to be approximately five.

Appendix 8.

Determining AMF symbiotic effectiveness by the pinnule technique and similar nondestructive approaches

Background

Because growth of host species in response to AMF infection largely results from increased uptake of P, one of the best ways to determine the symbiotic effectiveness of AMF fungi is to monitor the P status of host plants as the symbiosis develops. The pinnule technique⁽⁴⁵⁾ is a rapid, nondestructive, and precise technique for monitoring development of symbiotic effectiveness in the arbuscular mycorrhizal association.

Procedures for the pinnule technique

Selection of a suitable indicator plant

In selecting an indicator plant for the pinnule technique, the key criteria are that it must

- have compound leaves
- grow reasonably rapidly
- be moderately to very highly dependent on VAM fungi
- have pinnules or subleaflets that detach readily.

Species that are marginally dependent on VAM fungi could serve as indicator plants, but the range of soil solution P levels at which they will be useful is limited (M.H. and Manjunath, unpublished data). The species used in the initial development of the pinnule technique was *Leucaena leucocephala* cv. K8.⁽⁴⁴⁾ Subsequently, the method was demonstrated to be useful with a variety of tree species, including *Albizia ferruginea*, *Acacia koa*, *A. mangium*, *L. diversifolia*, *L. retusa*, *L. trichodes*, *Sesbania grandiflora*, *S. pachycarpa*, *S. sesban*, *S. tomentosa*, and *Sophora chrysophylla*.

Growth conditions

Growth conditions must be adjusted such that the plants will develop and grow normally in the presence of effective AM endophytes. What has been discussed previously under inoculum production with respect to environmental and soil factors applies here too. It is particularly important to keep in mind that the development of arbuscular mycorrhizas and their functions can be hampered by very low and very high phosphorus concentrations.

Sampling and sample preparation

Figure 23 diagrams a *L. leucocephala* leaf with its leaflets (pinnae) and subleaflets (pinnules). Pinnule sampling can begin at the appearance of a fully expanded second leaf, which can be as early as 10 days from planting. Subsequent sampling can be done as frequently as once every 3–5 days. The youngest fully open leaf is selected, and one or two pinnules may be removed per leaf at each sampling day from a fixed position on a leaf. Because P is mobile within the plant, the youngest pinnule on the youngest fully open leaf is the most sensitive indicator of AMF effectiveness. However, the youngest pinnule on a leaflet is often difficult to remove intact. Any other convenient pinnule position on a pinna of the youngest fully open leaf will do, since the variability in P content of pinnules from the same pinna is very small. We prefer sampling the fourth pinnule from the bottom of a pinna, because it is relatively easy to remove.

Figure 23. *Leucaena leucocephala* leaf showing pinna and pinnules.⁽⁴⁴⁾

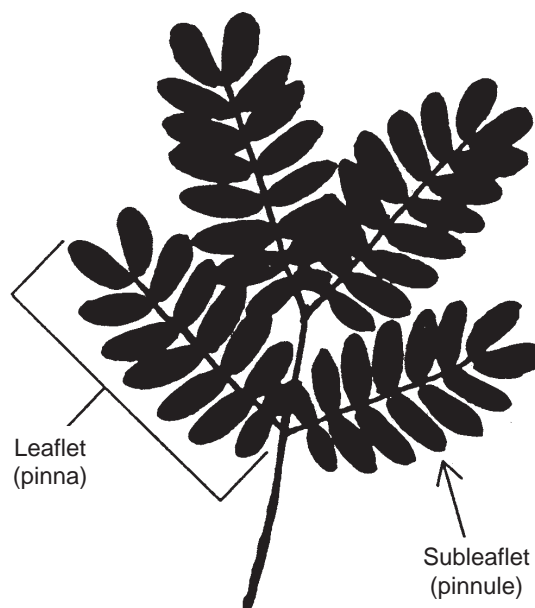
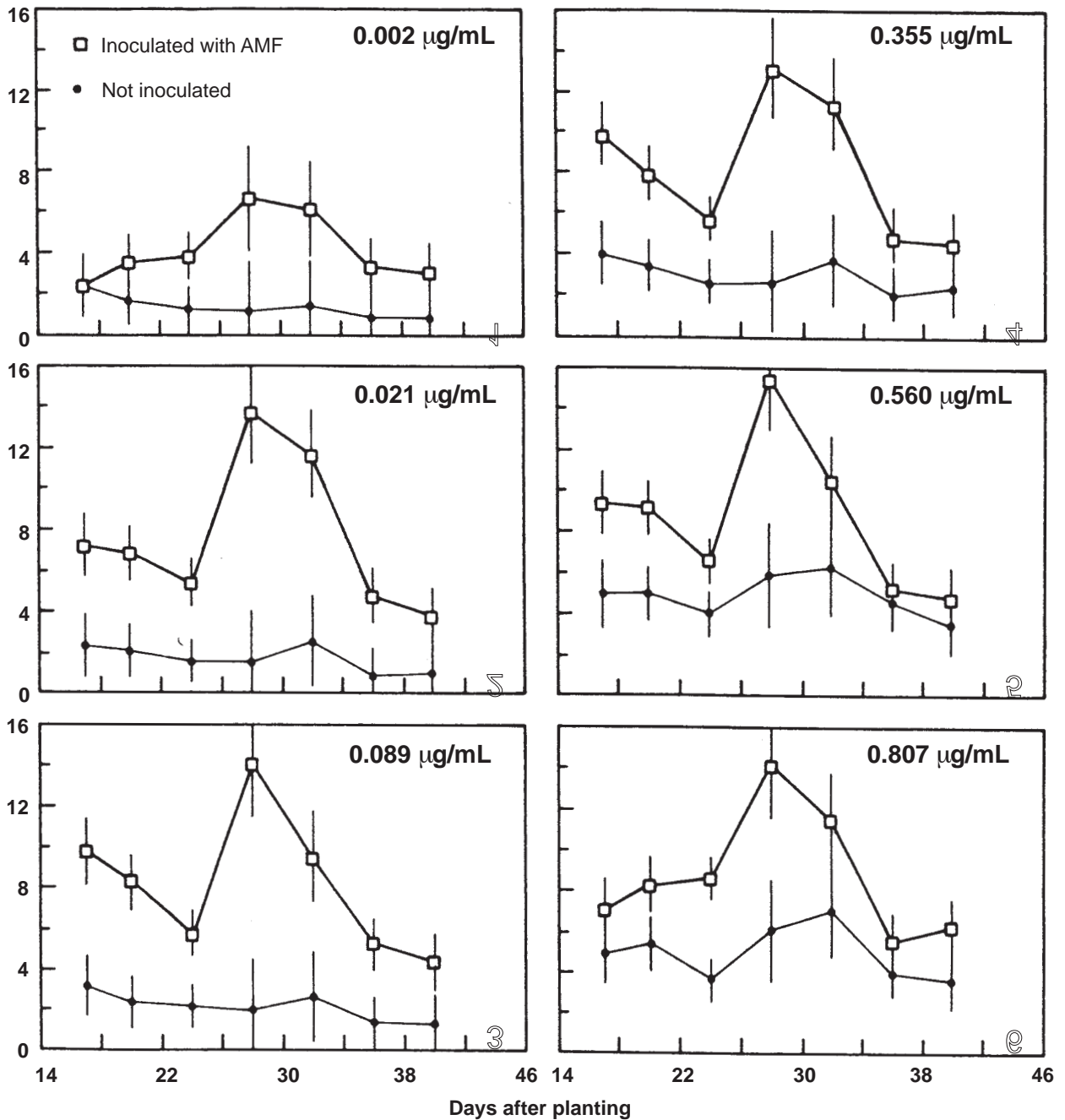

Figure 24. Symbiotic effectiveness of AM fungi in plants grown at six levels of soil-solution P, measured as total P content of *Leucaena leucocephala* pinnules; bars represent LSD 0.05.⁽⁴¹⁾



When soil-solution P is very low (graph 1), P uptake even by inoculated plants is also low. As the level of P in the soil solution increases, this plant is increasingly capable of removing P on its own, as shown by the increased uptake over graphs 2 through 6 by the plants that were not inoculated (solid circles). Also, as the soil P level increases, the significant differences in P uptake between mycorrhizal and nonmycorrhizal plants (graphs 2–4) can be seen to diminish (graphs 5 and 6).

Figure 25 shows that the pattern of P concentration in the pinnule is similar to that of its P content over the soil-solution P levels tested in this experiment. The practical implication of this similarity is that the pinnule P content analysis can be used directly, and the need to weigh pinnules for the purpose of calculating P concentration is thus avoided.

Figure 25. Symbiotic effectiveness of AM fungi in plants grown at six levels of soil-solution P, measured as concentration of P in *Leucaena leucocephala* pinnules; bars represent LSD 0.05.⁽⁴¹⁾

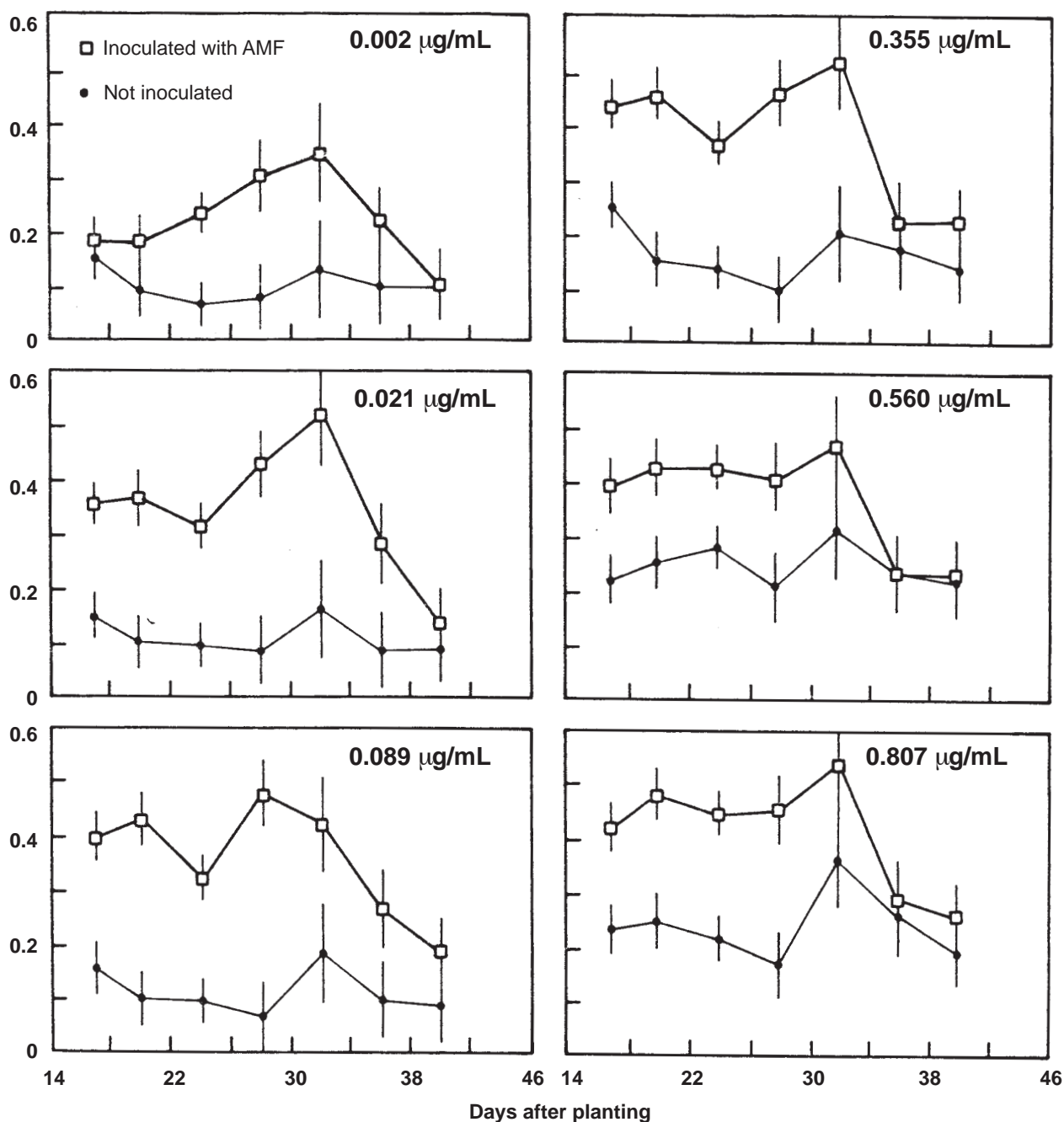

Pinnules from a given sample are deposited in labeled plastic vials and brought to the laboratory for drying (70°C, 4 h). Pinnules are then weighed (if P concentration calculations are to be made), transferred into 18 x 150-mm Pyrex test tubes, and ashed in a muffle furnace (500°C, 3 h).

Analysis of ashed samples

The ash is dissolved and color is developed according to the molybdenum blue technique.⁽⁷⁹⁾ To achieve this, 2.5 mL of reagent B is added to the test tube containing the ashed sample. This is followed by 10 mL of distilled or deionized water. The contents are then mixed

thoroughly using a vortex mixer. After 20 min of standing, the intensity of the color that develops is measured in a spectrophotometer at a wave length of 882 nm. Reagent B is prepared by dissolving 0.428 g of ascorbic acid in 100 mL of reagent A. Reagent A is prepared by dissolving 0.35 g of antimony potassium tartrate in 2.7 L of distilled or deionized water, adding to it 168 mL of concentrated sulfuric acid, dissolving 14.43 g of ammonium molybdate in it. This solution is stored in a dark bottle and used as needed. It is good for at least 2 months. Reagent B should be made daily.

Calculations

The concentration of P in a sample is determined by referring to a standard curve prepared by plotting the absorbance of standard P solutions against P concentration. P concentration values so obtained are multiplied by 12.5 to obtain the total P per pinnule in μg . This value in turn can be divided by the weight of the pinnule in order to express P as a percentage. Both expressions give comparable results for pinnule samples taken from *L. leucocephala* (Figures 24 and 25). It is, however, advantageous to express results as total P content, because this does not require weighing the pinnules.

Procedures for plants that do not form pinnules

The leaf disk or punch approach can be used for plant species that do not form pinnules.⁽³⁾ In some species, the leaf blades are so slender so that leaf disks cannot be readily taken; for these species, leaf P status can be determined by taking leaf tip samples. The principles discussed under the pinnule technique are applicable to the leaf disk and leaf tip approaches. The main difference between the approaches lies in the kind of indicator plants and the sampling procedure. Leaf disk samples can be taken with a cork borer or paper punch, and disk sizes of approximately 0.5 cm^2 have been shown to be sufficient in a number of plant species.⁽⁴³⁾ The length of leaf tip to be removed for P analysis can vary depending on the slenderness of the leaf blade. In some of our studies involving grasses (M.H., unpublished), we have used leaf tips as long as 2.5 cm, whereas in others⁽⁴⁴⁾ we have used tips as short as 1 cm. For onions, a 1-cm leaf tip works well.

Appendix 9.

Determining the P-sorption capacity of soils

Background

Diffusion is the major mechanism by which P moves to the root surface. One of the key factors that determines the rate of P diffusion in soil is the concentration of P in the soil solution. There must be sufficient P in the soil solution in order to provide the gradient necessary for the movement of P from soil solution to root surfaces. In the presence of AMF, the concentration of P in the soil solution assumes a different kind of importance. First, AMF fungi can overcome diffusion-related constraints of nutrient uptake, and second, the concentration of P in the soil solution is inversely related to arbuscular mycorrhizal development and AMF activity. Because different soils have different inherent P-sorption capacity, a given quantity of P applied to different soils will result in different quantities of P in the soil solution, making valid soil-to-soil comparison of the impacts of P amendment very difficult. The solution to this problem is to base comparisons on the concentration of P remaining in the soil solution rather than on the basis of the quantity of P added to soils. The relationship between the amount of P added to a soil and that remaining in the soil solution is best characterized by constructing the P-sorption isotherm of the soil.

Procedure

Preparing soil samples

Prepare the soil sample by passing it through a 2-mm aperture sieve, and determine its moisture content. Weigh 3-g subsamples into 50-mL round-bottom polypropylene centrifuge tubes in triplicate.

Adding P

Prepare a 0.01M CaCl_2 solution, take aliquots of it, and add KH_2PO_4 in various amounts to create solutions containing different concentrations of P. When 30 mL of a particular P solution is added to the 3-g soil contained in the centrifuge tube, it should give you the desired concentration of added P in mg/kg. For example, if you dissolve 0.0264 g of KH_2PO_4 in 150 mL of 0.01M

CaCl_2 and 30 mL of the solution is added into the centrifuge tube, the concentration of P added to the soil will be 400 mg/kg.

Incubating on shaker

To retard microbial activity, add two drops of toluene to each centrifuge tube that has received P or CaCl_2 solution. Tighten the screw caps (or stopper them tightly if the tubes are not screw-capped). Shake the contents of the tubes vigorously by hand for a few seconds to suspend the soil. Place the tubes on a shaking device, preferably a reciprocating shaker, in which case the tubes could be mounted on the shaker platform along with their rack. Shaking facilitates equilibration of the soil with the added phosphate. In our laboratory, samples are shaken on a reciprocating shaker for 30 minutes at 12-hour intervals for a period of 6 days.

Centrifugation and solution withdrawal

At the end of the 6-day equilibration period, centrifuge the samples at 10,000 rpm in a superspeed centrifuge. Withdraw 10 mL or less of the supernatant solution immediately after the centrifugation is over and transfer it to a 25-mL test tube. In our laboratory, we generally withdraw the supernatant liquid after filtering it through a Whatman #1 filter paper. If more than 8 μg P is expected in the aliquot, the volume pipetted out should be reduced from 10 mL to 5 mL or even 1 mL, with the total volume adjusted using deionized or distilled water. To minimize biological consumption of the P and avoid cross-contamination, it is advisable to analyze the sample with the lowest concentration of P first, and then proceed up the concentration range.

Color development

Add 2.5 mL of acid molybdate reagent (Murphy and Riley Reagent B)⁽⁷⁹⁾ with a dispenser to the sample aliquots in the test tubes. Mix by swirling or vortexing. Read the intensity of the color produced in a spectrophotometer at a wave length of 840 or 882 nm, depending on the sensitivity desired. Murphy and Riley Reagent B is prepared by dissolving 0.428 g of L-ascor-

Figure 26. P-sorption isotherms of four soils from Hawaii.

(Courtesy of R.L. Fox, used with permission).

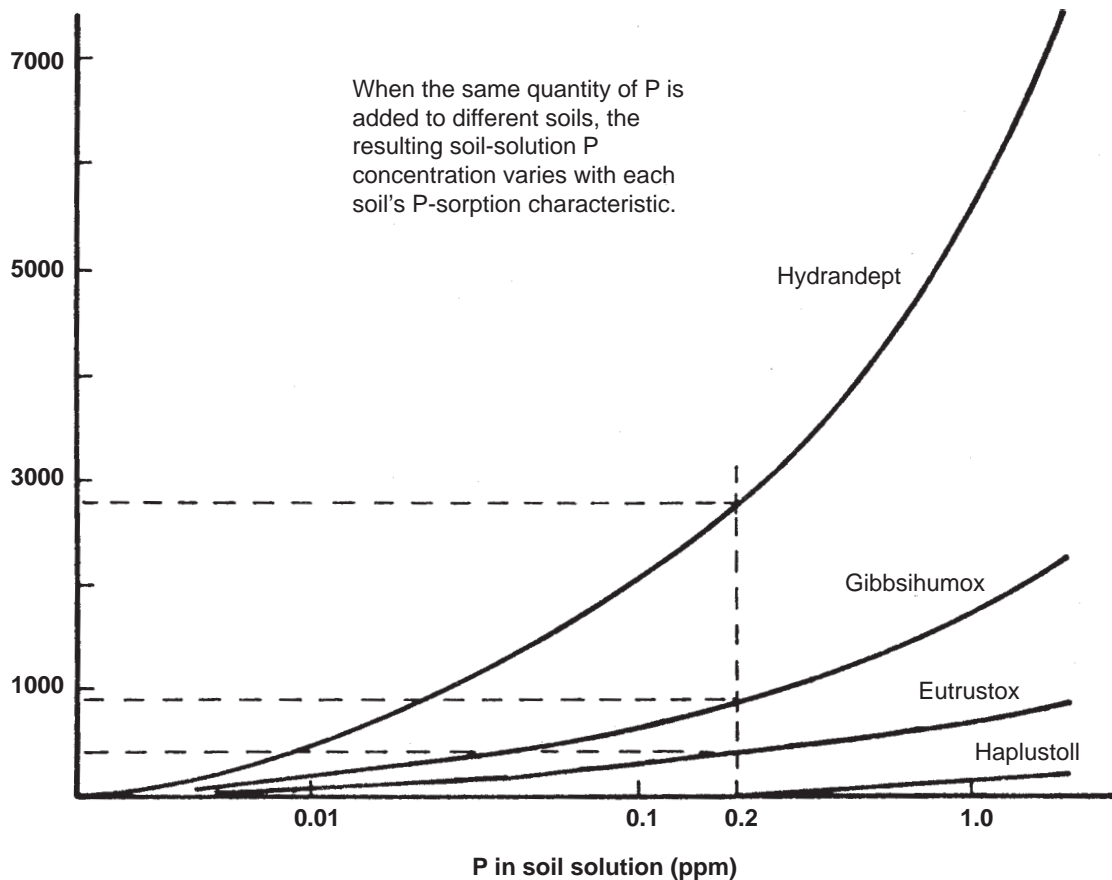

bic acid in 100 mL of reagent A. Murphy and Riley Reagent A is prepared by dissolving 0.35 g of antimony potassium tartrate in 2.7 L of distilled or deionized water, adding to it 168 mL of concentrated sulfuric acid, dissolving 14.43 g of ammonium molybdate in the solution, adding 120 mL of deionized or distilled water. This solution is stored in a dark bottle and used as needed. It is good for at least 2 months. Reagent B should be made daily.

Calculations

Correct sample absorbance readings by subtracting the absorbance of your reagent blank (0.01M CaCl_2 solution plus Reagent B) and that of the sample background (soil extract without Reagent B). Plot the absorbance of standard P solutions vs. concentration and obtain the concentration of the unknown from the graph. Multiply the value by 1.25 to obtain the concentration of P remaining in solution as mg/L or $\mu\text{g/mL}$. Plot these values against P added (mg/kg) on a semilogarithmic graph

paper to obtain a P-sorption isotherm similar to those shown in Figure 26. Once the P-sorption isotherm is constructed, one can conveniently determine the amount P that must be added to obtain a target concentration of P in the soil solution. If researchers construct P sorption isotherms for the soils they use and report their results in terms of soil solution P rather than in terms of P added to the soils, they can begin to compare results in a valid way.

Chemical safety

Mouth-pipetting of any of the reagents used in this test can be dangerous, and should not be allowed. Reagent A contains antimony as well as molybdenum, both of which are very toxic. Collect all leftover reagents and samples containing them in a bottle labeled for this purpose so that they will be disposed off appropriately.

(Appendix 9 is adapted from Fox and Kamprath⁽²⁸⁾)

Appendix 10.

Monitoring the symbiotic effectiveness of indigenous AMF

Background

Knowing the aggregate effectiveness of AMF found in various soils is important because, as mentioned in the section on sources of AMF inocula, soils are sometimes used as AMF inocula. Moreover, the extent to which plant species respond to inoculation of soils with known AMF fungi will depend, among other things, on the host species, the P status of the soil, and the infectivity and effectiveness of indigenous AMF populations. A reliable method of determining the effectiveness of indigenous AMF fungi will contribute significantly to the use of soil as well as known AMF inocula with predictable outcomes.

Procedure

Preparing the soil

Obtain a soil with moderate to high P-adsorbing capacity. Crush the soil so that it will pass a 2-mm aperture sieve. Mix one part of the soil to one part of sand by weight. Adjust the pH of the sand-soil medium to 6.0–6.5. Sterilize the medium by autoclaving (121°C for 1 hour two times, separated from each other by 2–3 days) or by some convenient means. In our studies, we have used mansand instead of sand and the Leilehua (Typic Kandihumult) or the Wahiawa (Rhodic Eutruxox) soil.

Optimizing for AMF activity

Transfer 2 kg of the soil into 15-cm x 15-cm plastic pots. Determine the P-adsorption isotherm of the soil as in Appendix 9 and adjust the P content of the soil in the pots to 0.02 mg/L. Inoculate the soil with 100 g (dry weight basis) of a freshly collected soil, 2.5 g of a freshly produced crude inoculum of AMF containing four to eight infective propagules per gram of soil, or do not inoculate at all. Add nutrients other than P in amounts sufficient for normal growth of the indicator plant.⁽⁴⁾

Evaluating AMF effectiveness

Germinate seeds of a highly to very highly mycorrhiza-dependent indicator plant and plant the seeds at the rate of two seeds per pot to be thinned to one plant per pot 10 days after emergence. The indicator plant of choice in our program is *Leucaena leucocephala*. Grow the plants in the greenhouse or growth chamber with adequate light. Start sampling pinnules or leaf disks as soon as the second true leaf is fully expanded, and determine the P content of the samples as described in Appendix 8. Compare the effectiveness of the soil inoculum to that of the known inoculum by constructing AMF effectiveness graph for each soil tested as shown in Figures 2–5.

Appendix 11.

Table of most probable numbers for use with 10-fold dilutions, five tubes per dilution⁽¹⁷⁾

		Most probable number for indicated values of p_3					
p_1	p_2	0	1	2	3	4	5
0	0		0.180	0.036	0.054	0.072	0.09
0	1	0.018	0.036	0.055	0.073	0.091	0.11
0	2	0.037	0.055	0.074	0.092	0.110	0.13
0	3	0.056	0.074	0.093	0.110	0.130	0.15
0	4	0.075	0.094	0.110	0.130	0.150	0.17
0	5	0.094	0.110	0.130	0.150	0.170	0.19
1	0	0.020	0.040	0.060	0.080	0.100	0.12
1	1	0.040	0.061	0.081	0.100	0.120	0.14
1	2	0.061	0.082	0.100	0.120	0.150	0.17
1	3	0.083	0.100	0.130	0.150	0.170	0.19
1	4	0.110	0.130	0.150	0.170	0.190	0.22
1	5	0.130	0.150	0.170	0.190	0.220	0.24
2	0	0.045	0.068	0.091	0.120	0.140	0.16
2	1	0.068	0.092	0.120	0.140	0.170	0.19
2	2	0.093	0.120	0.140	0.170	0.190	0.22
2	3	0.120	0.140	0.170	0.200	0.220	0.25
2	4	0.150	0.170	0.200	0.230	0.250	0.28
2	5	0.170	0.200	0.230	0.260	0.290	0.32
3	0	0.078	0.110	0.130	0.160	0.200	0.23
3	1	0.110	0.140	0.170	0.200	0.230	0.27
3	2	0.140	0.170	0.200	0.240	0.270	0.31
3	3	0.170	0.210	0.24	0.280	0.310	0.35
3	4	0.210	0.240	0.28	0.320	0.360	0.40
3	5	0.250	0.290	0.32	0.370	0.410	0.45
4	0	0.130	0.170	0.21	0.250	0.300	0.36
4	1	0.170	0.210	0.26	0.310	0.360	0.42
4	2	0.220	0.260	0.32	0.380	0.440	0.50
4	3	0.270	0.330	0.39	0.450	0.520	0.59
4	4	0.340	0.400	0.47	0.540	0.620	0.69
4	5	0.410	0.480	0.56	0.640	0.720	0.81
5	0	0.230	0.310	0.43	0.580	0.760	0.95
5	1	0.330	0.460	0.64	0.840	1.100	1.30
5	2	0.490	0.700	0.95	1.200	1.500	1.80
5	3	0.790	1.100	1.40	1.800	2.100	2.50
5	4	1.300	1.700	2.20	2.800	3.500	4.30
5	5	2.400	3.500	5.40	9.200	16.000	

Literature cited

1. Abbot, L.K., and A.D. Robson. 1984. The effect of VA mycorrhizae in plant growth. In: C.L.I. Powell and D.J. Bagyaraj (eds). VA mycorrhiza. CRC Press, Inc., Boca Raton, Florida, USA. pp. 113–130.
2. Alexander, M. 1982. Most-probable-number method for microbial populations. In: A.L. Page (ed). Methods of soil analysis; part 2, Chemical and microbiological properties. American Society of Agronomy, Madison, Wisconsin, USA. pp. 815–820.
3. Aziz, T., and M. Habte. 1987. Determining vesicular-arbuscular mycorrhizal effectiveness by monitoring P status of leaf disks. Canadian Journal of Microbiology 33:1097–1101.
4. Aziz, T., and M. Habte. 1989. Influence of inorganic N on mycorrhizal activity, nodulation and growth of *Leucaena leucocephala* in an Oxisol subjected to simulated erosion. Communications in Soil Science and Plant Analysis 20:239–251.
5. Baon, J.B., S.E. Smith, and A.M. Alston. 1993. Mycorrhizal response of barley cultivars differing in P efficiency. Plant and Soil 157:97–105.
6. Bago, B., and C. Azcon-Aguilar. 1997. Changes in the rhizosphere pH induced by arbuscular mycorrhiza formation in onion (*Allium cepa*). Zeitschrift Fur Pflanzen Und Bodenkunde 160:333–339.
7. BEG (Bank of European Glomales). <www.bio.ukc.ac.uk/beg> (accessed April 2001).
8. Bethlenfalvai, G.J. 1992. Mycorrhiza and crop productivity. In: G.J. Bethlenfalvai and R.G. Linderman (eds), Mycorrhizae in sustainable agriculture. ASA/CSSA/SSSA, Madison, Wisconsin, USA. pp. 1–27.
9. Bethlenfalvai, G.J., I.C. Cantrell, K.L. Mihara, and R.P. Schreiner. 1998. Relationship between soil aggregation and mycorrhiza as influenced by soil biota and nitrogen. Biology and Fertility of Soils 28:356–363.
10. Bolan, N.S. 1991. A critical review on the role of mycorrhizal fungi in the uptake of phosphorus by plants. Plant and Soil 134:189–293.
11. Boswell, E.P., R.T. Koide, D.L. Shumway, and H.D. Addy. 1998. Winter wheat cover cropping, VA mycorrhizal fungi and growth and yield. Agriculture, Ecosystems and the Environment 67:55–65.
12. Brundrett, M., and S. Juniper. 1995. Non-destructive assessment of spore germination of VAM fungi and production of pot cultures from single spores. Soil Biology and Biochemistry 27(1):85–91.
13. Brundrett, L.M.C., Y. Piche, and R.L. Peterson. 1984. A new method for observing the morphology of vesicular-arbuscular mycorrhizae. Canadian Journal of Botany 62:2128–2134.
14. Brundrett, M., L. Peterson, L. Melville, H. Addy, T. McGonigle, G. Schaffer, N. Bougher, and H. Massicotte. 1994. Practical methods in mycorrhizal research. University of Guelph, Guelph, Ontario, Canada.
15. Bryla, D.R., and R.T. Koide. 1998. Mycorrhizal response of two tomato genotypes relates to their ability to acquire and utilize phosphorus. Annals of Botany 82:849–857.
16. Chambers, C.A., S.A. Smith, and F.A. Smith. 1980. Effect of ammonium and nitrate on mycorrhizal infection, modulation and growth of *Trifolium subterraneum*. New Phytologist 85:46–62.
17. Cochran, W.G. 1950. Estimation of bacterial densities by means of the “most probable number.” Biometrics 2:105–116.
18. Cooper, K.M., and G.S. Grandison. 1986. Interaction of vesicular-arbuscular mycorrhizal fungi and root knot nematode on cultivars of tomato and white clover susceptible to *Meloidogyne hapla*. Annals of Applied Biology 108:555–565.
19. Crush, J.R., and M.J.M. Hay. 1981. A technique for growing mycorrhizal clover in solution culture. New Zealand Journal of Agricultural Research 24:371–372.
20. Culley, J.L.B., E.F. Bolton, and B. Bernyk. 1983. Suspended solids and phosphorus loads from a clay soil; I. Plot studies. Journal of Environmental Quality 12:493–503.
21. Daniels, B.A., and H.D. Skipper. 1982. Methods for the recovery and quantitative estimation of propagules from soil. In: S.N.C. Chenck (ed), Methods and principles of mycorrhizal research. Ameri-

- can Phytopathological Society, St. Paul, Minnesota, USA. pp. 29–35.
22. Dodd, J.C., and B.D. Thomson. 1994. The screening and selection of inoculant arbuscular-mycorrhizal and ectomycorrhizal fungi. *Plant and Soil* 159:149–158.
 23. Elmes, R.P., C.M. Hepper, D.S. Hayman, and J. O'shea. 1983. The use of vesicular-arbuscular mycorrhizal roots grown by the nutrient film technique as inoculum for field sites. *Annals of Applied Biology* 104:437–441.
 24. Evans, D.G., and M.H. Miller. 1990. The role of the external mycelium network in the effect of soil disturbance upon vesicular-arbuscular mycorrhizal colonization of maize. *New Phytologist* 114:65–71.
 25. Ferguson, J.J., and J.A. Menge. 1982. Factors that affect production of endomycorrhizal inoculum. *Proceedings, Florida State Horticultural Society* 95:37–39.
 26. Ferguson, J.J., and S.H. Woodhead. 1982. Production of endomycorrhizal inoculum. Increase and maintenance of vesicular-arbuscular mycorrhizal fungi. In: N.C. Schenk (ed), *Methods and principles of mycorrhizal research*. The American Phytopathological Society, St. Paul, Minnesota, USA. pp. 47–54.
 27. Fitter, A.H. 1991. Cost benefits of mycorrhizas; implications for functioning under natural conditions. *Experientia* 47:350–355.
 28. Fox, R.L., and E.J. Kamprath. 1970. Phosphate solution isotherms for evaluating the phosphate requirements of soils. *Soil Science Society of America Proceedings* 34:902–907.
 29. Frankenberger, W.T. Jr., and M. Arshad. 1995. *Phytohormones in soils*. Marcel-Dekker, Inc. New York.
 30. Fries, L.L.M., R.S. Pacovsky, G.R. Safir and J. Kaminsky. 1998. Phosphorus effect on phosphatase activity in endomycorrhizal maize. *Physiologia Plantarum* 103:152–71.
 31. Gavito, M.F., and M.H. Miller. 1998. Early phosphorus nutrition, mycorrhizal development, dry matter partitioning and yield of maize. *Plant and Soil* 199:177–186.
 32. Gardner, W.K., D.A. Barber, and D.G. Barbery. 1983. The acquisition of phosphorus by *Lupinus albus* L; III. The probable mechanism by which phosphorus movement in the soil/root interface is enhanced. *Plant and Soil* 70:104–124.
 33. Gerdemann, J.W. 1975. Vesicular-arbuscular mycorrhiza. In: J.G. Torrey and D.T. Clarkson (eds), *The development and functions of roots*. Academic Press, London, UK. pp. 575–591.
 34. Giovannetti, M., and B. Mosse. 1980. An evaluation of techniques for measuring vesicular-arbuscular mycorrhizal infection in roots. *New Phytologist* 84:489–500
 35. Graham, J.H., and J.P. Syvertsen. 1985. Host determinants of mycorrhizal dependency of citrus rootstock seedlings. *New Phytologist* 101:667–676
 36. Graham, J.H., R.T. Leonard, and J.A. Menge. 1981. Membrane-related decrease in root exudation responsible for phosphorus inhibition of vesicular-arbuscular mycorrhiza formation. *Plant Physiology* 68:548–552.
 37. Graham, J.H., R.T. Leonard, and J.A. Menge. 1982. Interaction of light intensity and soil temperature with phosphorus inhibition of vesicular-arbuscular mycorrhiza formation. *New Phytologist* 91:683–690.
 38. Habte, M. 1989. Impact of simulated erosion on the abundance and activity of indigenous vesicular-arbuscular Mycorrhizal endophytes in an Oxisol. *Biology and Fertility of Soils* 7:164–167.
 39. Habte, M., and M.N. Byappanahalli. 1998. Influence of pre-storage drying conditions and duration of storage on the effectiveness of root inoculum of *Glomus aggregatum*. *Journal of Plant Nutrition* 21:1375–1389.
 40. Habte, M., and R.L. Fox. 1993. Effectiveness of VAM fungi in nonsterile soils before and after optimization of P in soil solution. *Plant and Soil* 151:219–226.
 41. Habte, M., and A. Manjunath. 1987. Soil solution P status and mycorrhizal dependency in *Leucaena leucocephala*. *Applied Environmental Microbiology* 53:791–801.
 42. Habte, M., and A. Manjunath. 1991. Categories of vesicular-arbuscular mycorrhizal dependency of host species. *Mycorrhiza* 1:3–12.
 43. Habte, M. D. Turk. 1991. Response of two species of *Cassia* and *Gliricidia sepium* to vesicular-arbuscular infection. *Communications in Soil Science and Plant Analysis* 22:1861–1872.
 44. Habte, M., R.L. Fox, and R.S. Huang. 1987. Determining vesicular-arbuscular mycorrhizal effectiveness by monitoring P status of subleaflets of an indicator plant. *Communications in Soil Science and Plant Analysis* 18:1403–1420.
 45. Habte, M., Y.C. Zhang and D.P. Schmidt. 1999.

- Effectiveness of *Glomus* species in protecting white clover against nematode damage. *Canadian Journal of Botany* 77:135–139.
46. Habte, M., R.L. Fox, T. Aziz, and Samir A. El-Swaify. 1988. Interaction of vesicular-arbuscular mycorrhizal fungi with erosion in an Oxisol. *Applied Environmental Microbiology* 54:945–950.
47. Harley, J.L., and S.E. Smith. 1983. *Mycorrhizal symbiosis*. Academic Press, New York.
48. Harris, D., and E.A. Paul. 1987. Carbon requirements of vesicular-arbuscular mycorrhizae. In: G. R. Safir (ed), *Ecophysiology of VA mycorrhizal plants*. CRC Press, Inc., Boca Raton, Florida, USA. pp. 93–105.
49. Hayman, D.S. 1982. Influence of soils and fertility on the activity and survival of arbuscular mycorrhizal fungi. *Phytopathology* 72:1119–1125.
50. Hayman, D.S. 1983. The physiology of vesicular-arbuscular endomycorrhizal symbiosis. *Canadian Journal of Botany* 61:944–963.
51. Hetrick, B.A.D., D.G. Kitt, and G.T. Wilson. 1988. Mycorrhizal dependence and growth habits of warm-season and cool-season tall grass prairie plants. *Canadian Journal of Botany* 66:1376–1380.
52. Hoagland, D.R., and D.I. Arnon. 1950. The water-culture method for growing plants without soil. *California Agricultural Experiment Station Circular* 347.
53. Hooker, J.E., M. Jaizme-Vegas, and D. Atkinson. 1994. Biocontrol of plant pathogens using arbuscular mycorrhizal fungi. In: S. Gianinazzi and H. Schuepp (eds), *Impacts of arbuscular mycorrhizal on sustainable agriculture and natural ecosystems*. Birkhauser Verlag, Basel, Switzerland. pp. 191–199.
54. Howeler, R.H., D.G. Edwards, and C.J. Asher. 1981. Applications of the flowing solution culture techniques to study involving mycorrhizas. *Plant and Soil* 59:179–183.
55. Howeler, R.H., D.G. Edwards, and C.J. Asher. 1982. Establishment of an effective endomycorrhizal association on cassava in flowing solution culture and its effects on phosphorus nutrition. *New Phytologist* 90:229–238.
56. Hung, L., and D. Sylvia. 1988. Production of vesicular-arbuscular mycorrhizal fungus inoculum in aeroponic culture. *Applied Environmental Microbiology* 54(2):353–357.
57. INVAM (The International Culture Collection of Arbuscular and Vesicular Arbuscular Mycorrhizal Fungi). www.invam.caf.wvu.edu (accessed April 2001).
58. Jakobsen, I., E.J. Jones, and J. Larse. 1994. Hyphal phosphorus transport, a keystone to mycorrhizal enhancement of plant growth. In: S. Gianinazzi and S. Schuepp (eds), *Impacts of arbuscular mycorrhizal on sustainable agriculture and natural ecosystems*. Birkhauser Verlag, Basel, Switzerland. pp. 133–146.
59. Jarstfer, A.G., and D.M. Sylvia. 1992. Inoculum production and inoculation strategies for vesicular-arbuscular mycorrhizal fungi. In: F.B. Metting, Jr. (ed), *Soil microbial ecology: application in agricultural and experimental management*. Marcel-Dekker, Inc. New York.
60. Jarstfer, A.G., and D.M. Sylvia. 1995. Aeroponic culture of VAM fungi. In: A. Varma and B. Hock (eds), *Mycorrhiza; structure, function, molecular biology and biotechnology*. Springer-Verlag, Berlin. pp. 427–441.
61. Jasper, D.A., A.D. Robson, and L.K. Abbot. 1979. Phosphorus and the formation of vesicular-arbuscular mycorrhizal. *Soil Biology and Biochemistry* 11:501–505.
62. Jasper, D.A., L.K. Abbot, and A.D. Robson. 1989. Hyphae of a vesicular-arbuscular mycorrhizal fungus maintain infectivity in dry soil, except when the soil is disturbed. *New Phytologist* 112:101–107.
63. Johnson, N.C., and F.L. Pflieger. 1992. Vesicular-arbuscular mycorrhizae and cultural stresses. In G.J. Bethlenfalvay and R.G. Linderman (eds), *Mycorrhiza in sustainable agriculture*. Soil Science Society of America, Madison, Wisconsin, USA. pp. 71–79.
64. Johnson, N.C., J.H. Graham, and F.A. Smith. 1997. Functioning of mycorrhizal associations along the mutualism-parasitism continuum. *New Phytologist* 135:575–585.
65. Kabir, Z., I.P. O'Halloran, and C. Hamel. 1999. Combined effects of soil disturbance and fallowing on plant and fungal components of mycorrhizal corn (*Zea mays* L.). *Soil Biology and Biochemistry* 31:307–314.
66. Khalil, S., T.E. Loynachan, and M.A. Tabatabai. 1999. Plant determinants of mycorrhizal dependency in soybean. *Agronomy Journal* 91:135–141.
67. Koide, R.T. 1991. Nutrient supply, nutrient demand and plant response to mycorrhizal infection. *New Phytologist* 117:365–386.
68. Koide, R.T., and R.P. Schreiner. 1992. Regulation of the vesicular-arbuscular mycorrhizal symbiosis.

-
- Annual Review of Plant Physiology and Plant Molecular Biology 43:557–581.
69. Kormanik, P.P., A.C. McGraw, and R.C. Shultz. 1980. Procedures and equipment for staining large numbers of plant roots for endomycorrhizal assay. *Canadian Journal of Microbiology* 26:536–538.
70. Koske, R.E., and J.N. Gemma. 1989. A modified procedure for staining roots to detect VA mycorrhiza. *Mycological Research* 92:486–488.
71. Lambert, D.H., D.E. Baker, and H. Cole, Jr. 1979. The role of mycorrhizae in the interactions of phosphorus with zinc, copper and other elements. *Soil Science Society of America Journal* 43:976–980.
72. McGonigle, T.P., D.G. Evans, and M.H. Miller. 1990. Effect of degree of soil disturbance on mycorrhizal colonization and phosphorus uptake by maize in growth chamber and field experiments. *New Phytologist* 116:629–636.
73. Manjunath, A., and M. Habte. 1988. The development of vesicular-arbuscular mycorrhizal infection and the uptake of immobile nutrients in *Leucaena leucocephala*. *Plant and Soil* 106:97–103.
74. Manjunath, A., and M. Habte. 1991. Root morphological characteristics of host species having distinct mycorrhizal dependency. *Canadian Journal of Botany* 69:671–676.
75. Manjunath, A., and M. Habte. 1992. External and internal P requirements of plant species differing in their mycorrhizal dependency. *Arid Soil Research and Rehabilitation* 6:271–284.
76. Menge, J.A., D. Sterile, D.J. Bagyaraj, E.L.V. Johnson, and R.T. Leonard. 1978. Phosphorus concentration in plants responsible for inhibition of mycorrhizal infection. *New Phytologist* 80:575–578.
77. Miller, M.H., T.P. McGonigle, and H.D. Addy. 1995. Functional ecology of vesicular-arbuscular mycorrhizal fungi as influenced by phosphate fertilization and tillage in agricultural ecosystems. *Critical Reviews in Biotechnology* 15:241–255.
78. Mosse, B., and J.P. Thompson. 1984. VA inoculum production; I. Exploratory experiments with beans fungi. *Annals of Applied Biology* 99: 247–253.
79. Murphy, J., and J.P. Riley. 1962. A modified single solution method for the determination of phosphate in natural waters. *Anal. Chim. Acta.* 27:31–36.
80. Newsham, K.K., A.H. Fitter, and A.R. Watkinson. 1994. Root pathogenic and arbuscular mycorrhizal fungi determine fecundity of asymptomatic plants in the field. *Journal of Ecology* 82:805–814.
81. Ojala, J.C., W.M. Jarrel, J.A. Menge, and E.L.V. Johnson. 1983. Influence of mycorrhizal fungus on the mineral nutrition and yield of onion in saline soil. *Agronomy Journal* 75:255–259.
82. O’Keefe, D.M., and D.M. Sylvia. 1991. Mechanisms of vesicular-arbuscular mycorrhizal plant growth response. In: D.K. Arora; B. Rai, K.G. Mukerji, G.R. Knudsen (eds), *Handbook of applied mycology; vol. 1., Soil and plants.* Marcel-Dekker, Inc., New York. pp. 35–53.
83. Onguene, N.A., and M. Habte. 1995. Nitrogen and phosphorus requirements for raising mycorrhizal seedlings of *Leucaena leucocephala* in containers. *Mycorrhiza* 5:347–356.
84. Pacovsky, R.S. 1986. Micronutrient uptake and distribution in mycorrhizal or phosphorus-fertilized soybeans. *Plant and Soil* 95:379–388.
85. Peters, S.M., and M. Habte. 2001. Optimizing solution P concentration in a peat-based medium for producing mycorrhizal seedlings. *Arid Land Research and Management* (in press).
86. Phillips, J.M., and D.S. Hayman. 1970. Improved procedures for clearing and staining parasitic and vesicular-arbuscular mycorrhizal fungi for rapid assessment of infection. *Transactions of the British Mycological Society* 55:158–161.
87. Plenchette, C., J.A. Fortin, and V. Furlan. 1983. Growth response of several plant species to mycorrhiza in a soil of moderate P fertility; I. Mycorrhiza dependency under field conditions. *Plant and Soil* 70:191–209.
88. Pope, P.E., W.R. Chaney, J.D. Rhodes, and S.H. Woodhead. 1983. The mycorrhizal dependency of four hardwood tree species. *Canadian Journal of Botany* 61:412–417.
89. Raman, N. 1995. Mycorrhizal fungal inoculum: current knowledge and research needs, 191–192 pp. In: Supriyanto and J. Kartana. (eds), *Proceedings, Second Symposium on Biology and Biotechnology of Mycorrhizae.* Third Asian Conference on Mycorrhizae. Yogyakarta, Indonesia, 19–21 April 1994, Biotrop special publication no. 56, Bogor, Indonesia.
90. Ratnayake, M.R., T. Leonard, and J.A. Menge. 1978. Root exudation in relation to supply of phosphorus and its possible relevance to mycorrhizal formation. *New Phytologist* 81:543–552.
91. Ryan, M., and J. Ash. 1999. Effect of phosphorus and nitrogen on growth of pasture plants and VAM

-
- fungi in SE Australian soils with contrasting fertilizer histories (conventional and biodynamics). *Agricultural Ecosystems and Environment* 73:51–62.
92. Sharpley, A.N., S.J. Smith, O.R. Jones, W.A. Berg, and G.A. Coleman. 1992. The transport of bioavailable phosphorus in agricultural run-off. *Journal of Environmental Quality* 21:30–35.
93. Sieverding, E. 1991. Vesicular-arbuscular mycorrhiza management in tropical agroecosystems. Deutsche Gesellschaft für Technische Zusammenarbeit, Bremer, Germany.
94. Soedarjo, M., and M. Habte. 1995. Mycorrhizal and nonmycorrhizal host growth in response to changes in pH and P concentration in a manganiferous Oxisol. *Mycorrhiza* 5:337–345.
95. Son, C.L., and S.E. Smith. 1988. Mycorrhizal growth response interactions between photon irradiance and phosphorus nutrition. *New Phytologist* 108:305–314.
96. Stahl, P.D., S.E. Williams, and M. Christensen. 1988. Efficacy of native vesicular-arbuscular mycorrhizal fungi after severe soil disturbance. *New Phytologist* 110:347–354.
97. Sylvia, D.M. 1999. Mycorrhizal symbiosis. In: D.M. Sylvia, J. Furhrmann, P. Hartel., and D. Zuberer (eds), *Principles and applications of soil microbiology*. Prentice Hall, New Jersey, USA. pp. 408–426
98. Sylvia, D.M., and J.A.G. Jarstfer. 1992. Sheared-root inocula of vesicular-arbuscular mycorrhizal fungi. *Applied and Environmental Microbiology* 58:229–232.
99. Tester, M., S.E. Smith, and F.A. Smith. 1987. The phenomenon of mycorrhizal plants. *Canadian Journal of Botany* 65:419–431.
100. Thompson, J.P. 1986. Soilless culture of vesicular-arbuscular mycorrhizae of cereals: effects of nutrient concentration and nitrogen source. *Canadian Journal of Botany* 64:2282–2294
101. Tinker, P.B., and A. Gildon. 1983. Mycorrhizal fungi and ion uptake. In: D.A. Rob and W.S. Pierpoint (eds), *Metals and micronutrients, uptake and utilization by plants*. Academic Press, London, UK. pp. 21–32.
102. Trotta, A., G.C. Varese, E. Gnani, A. Fusconi, S. Sampo, and G. Berta. 1996. Interaction between the soil-borne root pathogen *Phytophthora nicotianae* var. *parasitica* and the arbuscular mycorrhizal fungus *Glomus mosseae* in tomato plants. *Plant and Soil* 185:199–209.
103. Tsang, A., and M.A. Maun. 1999. Mycorrhizal fungi increase salt tolerance of *Strophostyles helvola* in coastal foredunes. *Plant Ecology* 144:159–166.
104. Wright, S.F., and A. Upadhyaya. 1996. Extraction of an abundant and unusual protein from soil and comparison of hyphal protein of arbuscular mycorrhizal fungi. *Soil Science* 161:575–586.
105. Wright, S.F., and A. Upadhyaya. 1998. A survey of soils for aggregate stability and glomalin, a glycoprotein produced by hyphae of arbuscular mycorrhizal fungi. *Plant and Soil* 198:97–107.
106. Zobel, R.W., P. Del Tredici, and J. Torrey. 1976. Method for growing plants aeroponically. *Plant Physiology* 57: 344–346.